

**VILLAGE OF DOWNERS GROVE
REPORT FOR THE VILLAGE COUNCIL MEETING
MAY 21, 2013 AGENDA**

SUBJECT:	TYPE:	SUBMITTED BY:
Bid: 2013 Replacement Sidewalk Program and Sidewalk Rehabilitation Program (S-006) & Brick Sidewalk Replacements (S-009)	Resolution Ordinance ✓ Motion Discussion Only	Nan Newlon, P.E. Director of Public Works

SYNOPSIS

A motion is requested to authorize award of two contracts for annual sidewalk maintenance including:

- A contract for the 2013 Replacement Sidewalk Program to Schroeder & Schroeder, Inc. of Skokie, Illinois in the amount of \$156,075, and
- A contract for the 2013 Sidewalk Rehabilitation Project to Safe Step LLC of Hortonville, Wisconsin in the amount of \$101,050.

STRATEGIC PLAN ALIGNMENT

The goals for 2011 to 2018 include *Top Quality Infrastructure*.

FISCAL IMPACT

The FY13 Budget includes \$241,500 for these projects in the Capital Projects Fund (\$191,500 for S-006 and \$50,000 for S-009).

RECOMMENDATION

Approval on the June 4, 2013 consent agenda.

BACKGROUND

This year’s Replacement Sidewalk Program will include the replacement of deteriorated sidewalks, curb replacement, and the upgrading of existing sidewalk ramps to comply with ADA standards. This year’s program also includes work under CIP project S-009 for the removal and replacement of sidewalk where there are brick sidewalk remnants.

The recommended bid amount of \$156,075 for the Replacement Sidewalk Program includes a base bid of \$123,595, which covers both the concrete and brick sidewalk removals, and replacement of all with new concrete walk. At the request of the Park District staff also included an alternate bid to install brick sidewalks along the frontage of Wanschneider Park on Maple Avenue. The alternate bid amount is \$32,480.

The Sidewalk Rehabilitation Project will consist of the removal of trip hazards less than 1-1/8”, where no other sidewalk deficiencies exist, by saw-cutting the concrete, as was done in 2011 and 2012. This method of trip hazard removal is ADA compliant, is cost effective, clean, and efficient. In addition, the method does not require any excavation of the homeowner’s parkway or property. This year’s project will include approximately 600 or more locations within the village.

Bids were received on Wednesday, April 17, 2013 for both contracts. A synopsis of each contract bid is as follows:

Replacement Sidewalk Program

Contractor	Total Base + Alt Bid
GLOBE CONSTRUCTION*	Low Bid \$154,422.00
SCHROEDER & SCHROEDER	\$156,075.00
STRADA CONSTRUCTION	\$174,480.00
A LAMP CONCRETE	\$226,130.00
MONDI CONSTRUCTION	\$295,870.00

Sidewalk Rehabilitation Project

Contractor	Total Bid
SIDEWALKS PLUS USA LTD**	Low Bid \$92,880.00
SAFE STEP LLC	\$101,050.00

*The low bidder for the Replacement Sidewalk Program, Globe Construction, withdrew their bid as a result of an error in their unit price for the alternate bid.

**The apparent low bidder for the Sidewalk Rehabilitation Program, Sidewalks Plus USA LTD, was not considered because they advised staff that they did not intend to comply with the specification for dry-sawing, opting instead to use a wet-saw process. Project specifications require dry sawing to eliminate the mess and inconvenience associated with the slurry produced by wet-sawing.

Schroeder & Schroeder has satisfactorily performed work of similar scope for the communities of Schaumburg, Oak Park, Winnetka, Elk Grove Village, and Northbrook, and received positive references, and has worked as a sub-contractor on the Village's Roadway Resurfacing projects, with satisfactory results.

Safe Step LLC performed the 2011 & 2012 Rehabilitation Sidewalk Program, with very satisfactory results.

ATTACHMENTS

- Schroeder & Schroeder CFB-FW Contract
- Safe Step LLC CFB-FW Contract
- Contractor Evaluation Forms
- CIP Sheets (S-006 & S-009)



CALL FOR BIDS – FIXED WORKS PROJECT

- I. Name of Company Bidding: SCARDESSA & SCARDESSA INC.
- II. Instructions and Specifications:
- A. Bid No.: S-006-13
 - B. For: 2013 REPLACEMENT SIDEWALK PROGRAM
 - C. Bid Opening Date/Time: WEDNESDAY, APRIL 17, 2013 @ 10:00 AM
 - D. Pre-Bid Conference Date/Time: Wednesday, April 10, 2013 @ 10:00 AM (OPTIONAL)
 - E. Pre-Bid Conference Location: PUBLIC WORKS BUILDING, 5101 WALNUT AVENUE, DOWNERS GROVE, IL 60515
- III. Required of All Bidders:
- A. Bid Deposit: 5%
 - B. Letter of Capability of Acquiring Performance Bond: YES
- IV. Required of Awarded Contractor(s)
- A. Performance Bond or Letter of Credit: YES
 - B. Certificate of Insurance: YES

Legal Advertisement Published: Thursday, April 4, 2013

This document comprises 77 pages

RETURN ORIGINAL BID IN SEALED ENVELOPE MARKED WITH THE BID NUMBER AS NOTED ABOVE TO:

BRIAN PARKS
STAFF ENGINEER
VILLAGE OF DOWNERS GROVE
5101 WALNUT AVENUE
DOWNERS GROVE, IL 60515
PHONE: 630/434-5460
FAX: 630/434-5495
www.downers.us

Village of Downers Grove

CALL FOR BIDS – FIXED WORKS PROJECT

Bid No.: S-006-13

The VILLAGE OF DOWNERS GROVE will receive bids Monday thru Friday, 8:00 A.M. to 5:00 P.M. at the Public Works Building, 5101 Walnut Avenue, Downers Grove, IL 60515.

The Village Council reserves the right to accept or reject any and all bids, to waive technicalities and to accept or reject any item of any Bid.

The documents constituting component parts of this Contract are the following:

- I. CALL FOR BIDS
- II. TERMS & CONDITIONS
- III. GENERAL PROVISIONS
- IV. SPECIAL PROVISIONS
- V. BID & CONTRACT FORM

All Bidders MUST submit the entire bid package, with one original Bid Form. Upon formal Award, the successful Bid will automatically convert to a Contract, and the successful Bidder will receive a copy of the executed contract upon formal award of the Bid with the Notice of Award.

DO NOT DETACH ANY PORTION OF THIS DOCUMENT. INVALIDATION COULD RESULT.

I. CALL FOR BIDS and INSTRUCTIONS TO BIDDERS

1. GENERAL

- 1.1 Notice is hereby given that Village of Downers Grove will receive sealed bids up to: Wednesday, April 17, 2013 @ 10:00 AM
 - 1.2 Defined Terms:
 - 1.2.1 Village – the Village of Downers Grove acting through its officers or agents.
 - 1.2.2 Contract Documents – this document plus any drawings issued therewith, any addenda and the Bidder's completed proposal, bonds and all required certifications.
 - 1.2.3 Bid – this document completed by an individual or entity and submitted to the Village.
 - 1.2.4 Bidder – the individual or entity who submits or intends to submit a bid proposal to the Village.
 - 1.2.5 Contractor – the individual or entity whose bid is selected by the Village and who enters into a contract with the Village.
 - 1.2.6 Work – the construction or service defined herein.
 - 1.2.7 Day – unless otherwise stated all references to day "Day" "Days", "day" or "days" shall refer to calendar days.
 - 1.2.8 Proposal Guaranty – the required bid deposit.
 - 1.3 Bids must be received at the Village by the time and date specified. Bids received after the specified time and date will not be accepted and will be returned unopened to the Bidder.
 - 1.4 Bids shall be sent to the Village of Downers Grove, ATTN: Brian Parks, in a sealed envelope marked "SEALED BID". The envelope shall be marked with the name of the project, date, and time set for receipt of Bids. The bid package may be submitted any time prior to the time set for receipt of Bids.
 - 1.5 All Bids must be submitted on the forms supplied by the Village and signed by a proper official of the company submitting the Bid. Telephone, email and fax Bids will not be accepted.
 - 1.6 Under penalty of perjury, the Bidder certifies by submitting this Bid that he has not acted in collusion with any other Bidder or potential Bidder.
- ### **2. BID PREPARATION**
- 2.1 It is the responsibility of the Bidder to carefully examine the Contract Documents and to be familiar with all of the requirements, stipulations, provisions, and conditions surrounding the proposed Work.

Village of Downers Grove

- 2.2 The Bidder shall inspect the site of the proposed Work in detail, investigate and become familiar with all the local conditions affecting the Work and become fully acquainted with the detailed requirements of the Work. Submitting a Bid shall be a conclusive assurance and warranty that the Bidder has made these examinations and that the Bidder understands all requirements for the performance of the Work. If the Bid is accepted, the Bidder will be responsible for all errors in the Bid resulting from his willing or neglectful failure to comply with these instructions. IN NO CASE WILL THE VILLAGE BE RESPONSIBLE FOR ANY COSTS, EXPENSES, LOSSES OR CHANGES IN ANTICIPATED MARGINS OF PROFIT RESULTING FROM THE WILLING OR NEGLECTFUL FAILURE OF THE BIDDER TO MAKE THESE EXAMINATIONS. THE VILLAGE WILL NOT BE RESPONSIBLE FOR ANY COSTS, EXPENSES, LOSSES OR CHANGES IN ANTICIPATED MARGINS OF PROFIT RESULTING FROM THE WILLING OR NEGLECTFUL FAILURE OF THE CONTRACTOR TO PROVIDE THE KNOWLEDGE, EXPERIENCE AND ABILITY TO PERFORM THE WORK REQUIRED BY THIS CONTRACT. No changes in the prices, quantities or contract provisions shall be made to accommodate the inadequacies of the Bidder, which might be discovered subsequent to award of contract. The Bidder shall take no advantage of any error or omission in the Contract Documents nor shall any error or omission in the Contract Documents serve as the basis for an adjustment of the amounts paid to the Bidder.
- 2.3 When the Contract Documents include information pertaining to subsurface explorations, borings, test pits, and other preliminary investigations, such information is included solely for the convenience of the Bidder. *The Village assumes no responsibility whatsoever with respect to the sufficiency of the information, and does not warrant, neither expressly nor by implication, that the conditions indicated represent those existing throughout the Work, or that unanticipated developments may not occur.*
- 2.4 Any information shown in the Contract Documents regarding the locations of underground utility facilities is included solely for the convenience of the Bidder. The Village assumes no responsibility whatsoever with respect to the sufficiency, accuracy or inadequacy of such information. It shall be the Bidder's responsibility to obtain detailed information from the respective utility companies relating to the location of their facilities and the work schedules of the utility companies for removing or adjusting them. Utilities whose facilities may be affected by the work include, but may not be limited to, the following: Nicor, ComEd, SBC, Comcast Cable, Downers Grove Sanitary District, and Village water, storm sewer, and street lighting systems.
- 2.5 No oral or telephone interpretations of specifications shall be binding upon the Village. All requests for interpretations or clarifications shall be made in writing and received by the Village at least five (5) business days prior to the date set for receipt of Bids or the pre-bid conference, if offered. The Village shall make all changes or interpretations of the Contract Documents in a written addendum and shall provide an addendum to any Bidder of record. Any and all changes to the Contract Documents are valid only if they are included by written addendum to all Bidders. Each Bidder must acknowledge receipt of any addenda by indicating same on the Bid Form. Each Bidder, by acknowledging receipt of any addenda, is responsible for the contents of the addenda and any changes to the Bid therein. Failure to acknowledge any addenda may cause the Bid to be rejected. The Village will not assume responsibility for receipt of any addenda. In all cases, it will be the Bidder's responsibility to obtain all addenda issued. Bidders will provide written acknowledgement of receipt of each addendum issued with the bid submission.

Village of Downers Grove

- 2.6 An estimate of the quantities of Work to be performed and the materials to be furnished is shown in the Bid Form. It is given as a basis for comparing the properly submitted Bids, and shall be used by the Village in awarding the Contract. The Village does not expressly warrant nor imply that the estimated quantities shown will correspond with those quantities required to perform the Work. No Bidder shall plead misunderstanding or deception because of such an estimate of quantities, or because of the character, location or other conditions pertaining to the Work. Payment shall be based on the actual quantities of work properly performed in accordance with the Contract, at the Contract unit prices specified. The Village reserves the right to increase, decrease or omit entirely, any or all items. No allowance will be made for any change in anticipated profits due to an increase or decrease in the original estimate of quantities.
- 2.7 The Bidder must submit his Bid on the form furnished by the Village. The Bid shall be executed properly, and Bids shall be made for all items indicated in the Bid Form. The Bidder shall indicate, in figures, a unit price or lump sum price for each of the separate items called for in the Bid Form. The Bidder shall show the products of the respective quantities and unit prices in the column provided for that purpose. The gross sum shown in the place indicated in the Bid Form shall be the summation of said products. All writing shall be with ink or typewriter, except the signature of the Bidder, which shall be written with ink.
- 2.8 In case of error in the extension of prices in the Bid, the hourly rate or unit price will govern. In case of discrepancy in the price between the written and numerical amounts, the written amount will govern.
- 2.9 All costs incurred in the preparation, submission, and/or presentation of any Bid including the Bidder's travel or personal expenses shall be the sole responsibility of the Bidder and will not be reimbursed by the Village.
- 2.10 The Bidder hereby affirms and states that the prices quoted herein constitute the total cost to the Village for all work involved in the respective items, as well as the materials to be furnished in accordance with the collective requirements of the Contract Documents. The Bidder also affirms that this cost includes all insurance, bonds, royalties, transportation charges, use of all tools and equipment, superintendence, overhead expense, profits and other work, services and conditions necessarily involved in the work to be done.
- 2.11 The Bidder shall complete and submit with the Bid an "Affidavit" (IDOT Form BC-57, or similar) listing all uncompleted contracts, including subcontract work; all pending low bids not yet awarded or rejected, and equipment available.
- 2.12 The Bidder shall complete and submit with the Bid a "Municipal Reference List" indicating other municipalities for which the Bidder has successfully performed similar work.
- 3. PRE-BID CONFERENCE**
- 3.1 A pre-bid conference may be offered to provide additional information, inspection or review of current facilities or equipment, and to provide an open forum for questions from Bidders. This pre-bid conference is not mandatory (unless stated "Mandatory" on the cover of this document), but attendance by Bidders is strongly advised as this will be the last opportunity to ask questions concerning the Bid.

Village of Downers Grove

3.2 Questions may be posed in writing to the Village (faxed and emailed questions are acceptable), but must be received by the Village prior to the scheduled time for the pre-bid conference. Questions received will be considered at the conference. An addendum may be issued as a result of the pre-bid conference. Such an addendum is subject to the provisions for issuance of an addendum as set forth in Section 2.5 above.

3.3 No Contract Documents will be issued after the pre-bid conference except to attendees.

4. BID SUBMISSION

4.1 An original copy of the sealed bid marked as indicated in Section 1 shall be submitted to the Village.

4.2 A bid deposit will be required, which shall not exceed ten percent (10%) of the estimated cost of the work to be furnished. Such bid deposit shall be in the form of a bid bond, certified check, cash or money order. Checks shall be drawn upon a bank of good standing payable to the order of the Village and said deposit shall be forfeited to the Village in the event the Bidder neglects or refuses to enter into a contract and bond when required, with approved sureties, to execute the Work or furnish the material for the price mentioned in his Bid and according to the plans and specifications in case the contract shall be awarded to him.

4.3 Bids shall be publicly opened at the hour and place indicated above.

5. BID MODIFICATION OR WITHDRAWAL

5.1 A Bid that is in the possession of the Village may be altered by a letter bearing the signature or name of the person authorized for submitting a Bid, provided that it is received prior to the time and date set for the bid opening. Telephone, email or verbal alterations of a Bid will not be accepted.

5.2 A Bid that is in the possession of the Village may be withdrawn by the Bidder, up to the time set for the bid opening, by a letter bearing the signature or name of the person authorized for submitting Bids. Bids may not be withdrawn after the bid opening and shall remain valid for a period of ninety (90) days from the date set for the bid opening, unless otherwise specified.

5.3 Any Bidder who does not submit a Bid is requested to return the enclosed Statement of "No Bid" postcard. Bidders not submitting Bids or "No Bid Statement" may otherwise be removed from the Village's bid mailing list.

6. BID REJECTION

6.1 Bids that contain omissions, erasures, alterations, additions not called for, conditional bids or alternate bids not called for, or irregularities of any kind, shall be rejected as informal or insufficient. Bids otherwise acceptable, which are not accompanied by the proper Proposal Guaranty, shall also be rejected as informal or insufficient. The Village reserves the right however, to reject any or all Bids and to waive such technical error as may be deemed best for the interest of the Village.

7. BIDDER COMPETENCY

7.1 No Bid will be accepted from or contract awarded to any person, firm or corporation that is in arrears or is in default upon any debt or contract. The Bidder, if requested, must present evidence to the Village of ability and possession of necessary facilities, and financial resources to comply with the

Village of Downers Grove

terms of the Contract Documents. Evidence must be presented within three (3) business days.

8. BIDDER DISQUALIFICATION

8.1 Any one or more of the following causes may be considered as sufficient for the disqualification of a Bidder and the rejection of their Bid.

8.1.1 More than one Bid for the same Work from an individual, firm partnership, or corporation under the same or different names.

8.1.2 Evidence of collusion among Bidders.

8.1.3 Unbalanced Bids in which the prices for some items are substantially out of proportion to the prices for other items.

8.1.4 Failure to submit a unit price for each item of Work listed in the Bid Form.

8.1.5 Lack of competency as revealed by financial statement or experience questionnaire.

8.1.6 Unsatisfactory performance record as shown by past work, judged from the standpoint of workmanship and progress.

8.1.7 Uncompleted work which, in the judgment of the Village, might hinder or prevent the prompt completion of this Work.

8.1.8 Failure to submit a signed Bidder's Certificate stating the following:

8.1.8.1 That the Bidder is not barred from bidding on this Contract as a result of a violation of Sections 720 ILCS 5/33-E3 and 720 ILCS 5/33-E4 of the Illinois Compiled Statutes; and

8.1.8.2 The Bidder is not delinquent in the payment of any tax administered by the Illinois Department of Revenue; and

8.1.8.3 The Bidder will maintain the types and levels of insurance required by the terms of this contract; and

8.1.8.4 The Bidder will comply with the Illinois Prevailing Wage Act, 820 ILCS 130/1 *et seq.*

9. BASIS OF AWARD

9.1 The Village reserves the exclusive right to accept or reject any and all Bids or to waive sections, technicalities and irregularities, or to accept or reject any Bid or any item of any Bid.

10. AWARD OF CONTRACT

10.1 Unless the Village exercises its right to reject all Bids, the Contract will be awarded to that responsible Bidder whose Bid, conforming to the Contract Documents, will be most advantageous to the Village, price and other factors considered. (the credentials, financial information, bonding capacity, insurance protection, qualifications of the labor and management of the firm, past experience and ability to

Village of Downers Grove

complete the project within time frame required - lowest responsible bidder)

- 10.2 Unless otherwise specified, if a Contract is not awarded within ninety (90) days after the opening of Bids, a Bidder may file a written request with the Village for the withdrawal of their Bid. The Village will have a maximum of ten (10) days after the receipt of such request to award the Contract or release the Bidder from further obligation by return of the Bidder's bid deposit. Any attempt or actual withdrawal or cancellation of a Bid by the awarded contractor who has been notified by the Village of the acceptance of said Bid shall be considered a breach of contract.

11. RETURN OF BID DEPOSIT

- 11.1 The bid deposit of all except the three (3) lowest responsive bidders on each contract will be returned within fifteen (15) days after the opening of Bids. The remaining bid deposits of each contractor will be returned within fifteen (15) days after the Village Council has awarded the contract and the required appurtenances to the contract have been received.

12. FAILURE TO ENTER INTO CONTRACT

- 12.1 Failure on the part of the successful Bidder to execute a Contract and provide acceptable bonds, as provided herein, within ten (10) days from the date of receipt of the Contract and Notice of Award from the Village, will be considered as just cause for the revocation of the award. The Bidder's bid security shall then be forfeited to the Village, not as a penalty but in payment of liquidated damages sustained as a result of such failure.
- 12.2 The Bidder shall not be allowed to claim lack of receipt where the Contract and Notice of Award was mailed by U.S. Postal Services certified mail to the business address listed in his Bid. In case the Village does not receive evidence of receipt within ten (10) days of the date of Notice of Award, the Village may revoke the award. The Bidder shall then forfeit the bid security to the Village, not as a penalty but in payment of liquidated damages sustained as the result of such failure to execute the Contract.
- 12.3 By submitting a Bid, the Bidder understands and agrees that, if his Bid is accepted, and he fails to enter into a contract forthwith, he shall be liable to the Village for any damages the Village may thereby suffer.

13. SECURITY FOR PERFORMANCE

- 13.1 The successful Bidder shall, within ten (10) days after acceptance of the Bidder's Bid by the Village, furnish a Performance Bond and a Materials and Labor Payment Bond acceptable to the Village in the full amount of the Bid. Said bonds shall guarantee the Bidder's performance under the Contract Documents and shall guarantee payment of all subcontractors and material suppliers. Any bond shall include a provision as will guarantee faithful performance of the Illinois Prevailing Wage Act, 820 ILCS 130/1 et seq.

14. TAX EXEMPTION

- 14.1 The Village is exempt from Illinois sales or use tax for direct purchases of materials and supplies. A copy of the Illinois Sales Tax Exemption Form will be issued upon request. The Village's federal identification number will also be provided to the selected Bidder.

Village of Downers Grove

15. RESERVED RIGHTS

- 15.1 The Village reserves the right to waive sections, irregularities, technicalities and informalities to this Contract and to accept any Bid and to reject any and all Bids and to disapprove of any and all subcontractors as may be in the best interest of the Village. Time and date requirements for receipt of Bids, however, will not be waived.

16. CATALOGS AND SHOP DRAWINGS

- 16.1 Each Bidder shall submit catalogs, descriptive literature, and detailed drawings, where applicable, to fully illustrate and describe the work or material he proposes to furnish.

17. TRADE NAMES AND SUBSTITUTIONS

- 17.1 Certain materials and equipment are specified by a manufacturer or trade name to establish standards or quality and performance and not for the purpose of limiting competition. Products of other manufacturers may be substituted, if, in the opinion of the Village, they are equal to those specified in quality, performance, design, and suitability for intended use. If the Bidder proposes to furnish an "equal", the proposed "equal" item must be so indicated in the written Bid. Where two or more items are specified, the selection among those specified is the Bidder's option, or he may submit his Bid on all such items. Detail specification sheets shall be provided by Bidder for all substituted items.

II. TERMS AND CONDITIONS

18. VILLAGE ORDINANCES

- 18.1 The successful Bidder, now the Contractor, will strictly comply with all ordinances of the Village of Downers Grove and laws of the State of Illinois.

19. USE OF VILLAGE'S NAME

- 19.1 The Contractor is specifically denied the right of using in any form or medium the name of the Village for public advertising unless the Village grants express permission.

20. HOURS OF WORK

- 20.1 The Contractor shall do no work between the hours of 7:00 p.m. and 7:00 a.m., nor on Saturdays, Sundays or legal holidays, unless otherwise approved in writing by the Village. However, such work may be performed at any time if necessary, for the proper care and protection of work already performed, or in case of an emergency. All after-hour work is still subject to the permission of the Village.

21. PERMITS AND LICENSES

- 21.1 The Contractor shall obtain all necessary permits and licenses required to complete the Work. The cost of acquisition of all necessary permits, bonds, insurance and services as specified herein shall be considered INCIDENTAL, and no additional compensation will be allowed the Contractor.

22. INSPECTION

- 22.1 The Village shall have a right to inspect, by its authorized representative, any material, components or workmanship as herein specified. Materials, components or workmanship that have been rejected by the Village as not in accordance with the terms of the contract specifications shall be replaced by the Contractor at no cost to the Village.

23. DELIVERIES

- 23.1 All materials shipped to the Village must be shipped F.O.B. designated location, Downers Grove, Illinois.

24. SPECIAL HANDLING

- 24.1 Prior to delivery of any product that is caustic, corrosive, flammable or dangerous to handle, the Contractor will provide written directions as to methods of handling such products, as well as the antidote or neutralizing material required for its first aid before delivery. Contractor shall also notify the Village and provide material safety data sheets for all substances used in connection with this Contract which are defined as toxic under the Illinois Toxic Substances Disclosure to Employees Act.

25. NONDISCRIMINATION

- 25.1 Contractor shall, as a party to a public contract:

- 25.1.1 Refrain from unlawful discrimination in employment and undertake affirmative action to assure equality of employment opportunity and eliminate the effects of past discrimination;

Village of Downers Grove

25.1.2 By submission of this Bid, the Contractor certifies that he is an "equal opportunity employer" as defined by Section 2000(e) of Chapter 21, Title 42, U.S. Code Annotated and Executive Orders #11246 and #11375, which are incorporated herein by reference. The Equal Opportunity clause, Section 6.1 of the Rules and Regulations of the Department of Human Rights of the State of Illinois, is a material part of any contract awarded on the basis of this Bid.

25.2 It is unlawful to discriminate on the basis of race, color, religion, sex, national origin, ancestry, age, marital status, physical or mental handicap, military status, order of protection status, sexual orientation or unfavorable discharge for military service. Contractor shall comply with standards set forth in Title VII of the Civil Rights Act of 1964, 42 U.S.C. Sec. 2000 et seq., The Human Rights Act of the State of Illinois, 775 ILCS 5/1-101 et. seq, and The Americans With Disabilities Act, 42 U.S.C. Sec. 12101 et. seq.

26. SEXUAL HARASSMENT POLICY

26.1 The Contractor, as a party to a public contract, shall have a written sexual harassment policy that:

26.1.1 Notes the illegality of sexual harassment;

26.1.2 Sets forth the State law definition of sexual harassment;

26.1.3 Describes sexual harassment utilizing examples;

26.1.4 Describes the Contractor's internal complaint process including penalties;

26.1.5 Describes the legal recourse, investigative and complaint process available through the Illinois Department of Human Rights and the Human Rights Commission and how to contact these entities; and

26.1.6 Describes the protection against retaliation afforded under the Illinois Human Rights Act.

27. EQUAL EMPLOYMENT OPPORTUNITY

27.1 In the event of the Contractor's non-compliance with the provisions of this Equal Employment Opportunity Clause, the Illinois Human Rights Act or the Rules and Regulations of the Illinois Department of Human Rights ("Department"), the Contractor may be declared ineligible for future contracts or subcontracts with the State of Illinois or any of its political subdivisions or municipal corporations, and the contract may be canceled or voided in whole or in part, and such other sanctions or penalties may be imposed or remedies invoked as provided by statute or regulation. During the performance of this Contract, the Contractor agrees as follows:

27.1.1 That it will not discriminate against any employee or applicant for employment because of race, color, religion, sex, marital status, national origin or ancestry, age, physical or mental disability unrelated to ability, military status, order of protection status, sexual orientation, sexual identity, or an unfavorable discharge from military service; and further that it will examine all job classifications to determine if minority persons or women are underutilized and will take appropriate affirmative action to rectify any such underutilization.

Village of Downers Grove

- 27.1.2 That, if it hires additional employees in order to perform this Contract or any portion thereof, it will determine the availability (in accordance with the Department's Rules and Regulations) of minorities and women in the area(s) from which it may reasonably recruit and it will hire for each job classification for which employees are hired in such a way that minorities and women are not underutilized.
- 27.1.3 That, in all solicitations or advertisements for employees placed by it or on its behalf, it will state that all applicants will be afforded equal opportunity without discrimination because of race, color, religion, sex, marital status, national origin or ancestry, age, physical or mental disability unrelated to ability, military status, order of protection status, sexual orientation, or an unfavorable discharge from military services.
- 27.1.4 That it will send to each labor organization or representative of workers with which it has or is bound by a collective bargaining or other agreement or understanding, a notice advising such labor organization or representative of the Contractor's obligations under the Illinois Human Rights Act and the Department's Rules and Regulations. If any such labor organization or representative fails or refuses to cooperate with the Contractor in its efforts to comply with such Act and Rules and Regulations, the Contractor will promptly so notify the Department and the contracting agency and will recruit employees from other sources when necessary to fulfill its obligations thereunder.
- 27.1.5 That it will submit reports as required by the Department's Rules and Regulations, furnish all relevant information as may from time to time be requested by the Department or the contracting agency, and in all respects comply with the Illinois Human Rights Act and the Department's Rules and Regulations.
- 27.1.6 That it will permit access to all relevant books, records, accounts and work sites by personnel of the contracting agency and the Department for purpose of investigation to ascertain compliance with the Illinois Human Rights Act and the Department's Rules and Regulations.
- 27.1.7 That it will include verbatim or by reference the provisions of this clause in every subcontract it awards under which any portion of the contract obligations are undertaken or assumed, so that such provisions will be binding upon such subcontractor. In the same manner as with other provisions of this Contract, the Contractor will be liable for compliance with applicable provisions of this clause by such subcontractors; and further it will promptly notify the contracting agency and the Department in the event any subcontractor fails or refuses to comply therewith. In addition, the Contractor will not utilize any subcontractor declared by the Illinois Human Rights Commission to be ineligible for contracts or subcontracts with the State of Illinois or any of its political subdivision or municipal corporations.

28. DRUG FREE WORK PLACE

28.1 Contractor, as a party to a public contract, certifies and agrees that it will provide a drug free workplace by:

28.1.1 Publishing a statement:

(1) Notifying employees that the unlawful manufacture, distribution, dispensation, possession or use of a controlled substance, including cannabis, is prohibited in the Village's or

Village of Downers Grove

Contractor's workplace.

(2) Specifying the actions that will be taken against employees for violations of such prohibition.

(3) Notifying the employee that, as a condition of employment on such contract or grant, the employee will:

(A) abide by the terms of the statement; and

(B) notify the employer of any criminal drug statute conviction for a violation occurring in the workplace no later than five (5) days after such conviction.

28.1.2 Establishing a drug free awareness program to inform employees about:

(1) the dangers of drug abuse in the workplace;

(2) the Village's or Contractor's policy of maintaining a drug free workplace;

(3) any available drug counseling, rehabilitation and employee assistance programs;

(4) the penalties that may be imposed upon employees for drug violations.

28.1.3 Providing a copy of the statement required by subparagraph 1.1 to each employee engaged in the performance of the contract or grant and to post the statement in a prominent place in the workplace.

28.1.4 Notifying the contracting or granting agency within ten (10) days after receiving notice under part (3)(B) of subparagraph 1.1 above from an employee or otherwise receiving actual notice of such conviction.

28.1.5 Imposing a sanction on, or requiring the satisfactory participation in a drug abuse assistance or rehabilitation program by, any employee who is so convicted as required by section 5 of the Drug Free Workplace Act.

28.1.6 Assisting employees in selecting a course of action in the event drug counseling, treatment and rehabilitation is required and indicating that a trained referral team is in place.

28.1.7 Making a good faith effort to continue to maintain a drug free workplace through implementation of the Drug Free Workplace Act.

29. **SUBSTANCE ABUSE PREVENTION ON PUBLIC WORKS PROJECTS ACT**

29.1 In the event this is a public works project as defined under the Prevailing Wage Act, 820 ILCS 130/2, Contractor agrees to comply with the Substance Abuse Prevention on Public Works Projects Act, 820 ILCS 265/1 *et seq.*, and further agrees that all of its subcontractors shall comply with such Act. As required by the Act, Contractor agrees that it will file with the Village prior to commencing work its written substance abuse prevention program and/or that of its subcontractor(s) which meet or exceed the requirements of the Act.

30. **PREVAILING WAGE ACT**

30.1 Contractor agrees to comply with the Illinois Prevailing Wage Act, 820 ILCS 130/1 *et seq.*, for all work completed under this Contract. Contractor agrees to pay the prevailing wage and require that all of its subcontractors pay prevailing wage to any laborers, workers or mechanics who perform work pursuant to this Contract or related subcontract. For applicable rates, go to the State of Illinois – Department of Labor website (www.state.il.us/agency/idol/rates/rates.HTM) and use the most current

Village of Downers Grove

DuPage County rate. The Department revises the prevailing wage rates and the Contractor or subcontractor has an obligation to check the Department's website for revisions to prevailing wage rates throughout the duration of this Contract.

- 30.2 Contractor and each subcontractor shall keep or cause to be kept accurate records of all laborers, mechanics and other workers employed by them on the public works project, which records must include each worker's name, address, telephone number when available, social security number, classification, hourly wage paid (including itemized hourly cash and fringe benefits paid in each pay period), number of hours worked each day, and the starting and ending times of work each day. These records shall be open to inspection at all reasonable hours by any representative of the Village or the Illinois Department of Labor and must be preserved for three (3) years from the date of the last payment on the public work.
- 30.3 Since this is a contract for a public works project, as defined in 820 ILCS 130/2, Contractor agrees to post at the job site in an easily accessible place, the prevailing wages for each craft or type of worker or mechanic needed to execute the contract or work to be performed.
- 30.4 Because this is a public works project as defined under the Prevailing Wage Act, 820 ILCS 130/2, any and all contractors and subcontractors shall submit certified payroll records to the Village no later than the tenth (10th) day of each calendar month for the immediately preceding month in which construction on a public works project has occurred. **WITHOUT THIS PAPERWORK, NO INVOICE SHALL BE PAID BY THE VILLAGE.** Contractors and subcontractors must also submit a statement affirming that the records are true and accurate, that the wages paid to each worker are not less than the prevailing rate, and that the contractor and subcontractor are aware that filing false records is a Class A misdemeanor. The records must include the name, address, telephone number, social security number, job classification, hours of work, hourly rate, and start and end time of work each day for every worker employed on the public work. The Village reserves the right to check the pay stubs of the workers on the job. The Village further cautions that payment for any services rendered pursuant to this Contract may be predicated upon receipt of said records.
- 30.5 In the event that this is a construction project where Motor Fuel tax monies or state grant monies are used in the construction, maintenance and extension of municipal streets, traffic control signals, street lighting systems, storm sewers, pedestrian subways or overhead crossings, sidewalks and off-street parking facilities, and the like, the Village will require an Apprenticeship and Training Certification, attached after the Bidder's Certification.
- 30.6 Any bond furnished as security for performance shall include a provision as will guarantee faithful performance of the Illinois Prevailing Wage Act, 820 ILCS 130/1 et seq.

31. PATRIOT ACT COMPLIANCE

- 31.1 The Contractor represents and warrants to the Village that neither it nor any of its principals, shareholders, members, partners, or affiliates, as applicable, is a person or entity named as a Specially Designated National and Blocked Person (as defined in Presidential Executive Order 13224) and that it is not acting, directly or indirectly, for or on behalf of a Specially Designated National and Blocked Person.

Village of Downers Grove

The Contractor further represents and warrants to the Village that the it and its principals, shareholders, members, partners, or affiliates, as applicable are not, directly or indirectly, engaged in, and are not facilitating, the transactions contemplated by this Contract on behalf of any person or entity named as a Specially Designated National and Blocked Person. The Contractor hereby agrees to defend, indemnify and hold harmless the Village, and its elected or appointed officers, employees, agents, representatives, engineers and attorneys, from and against any and all claims, damages, losses, risks, liabilities and expenses (including reasonable attorney's fees and costs) arising from or related to any breach of the foregoing representations and warranties.

32. INSURANCE REQUIREMENTS

32.1 Prior to starting the Work, Contractor and any Subcontractors shall procure, maintain and pay for such insurance as will protect against claims for bodily injury or death, or for damage to property, including loss of use, which may arise out of operations by the Contractor or Subcontractor or any Sub-Sub Contractor or by anyone employed by any of them, or by anyone for whose acts any of them may be liable. Such insurance shall not be less than the greater of coverages and limits of liability specified below or any coverages and limits of liability specified in the Contract Documents or coverages and limits required by law unless otherwise agreed to by the Village.

Workers Compensation	\$500,000	Statutory
Employers Liability	\$1,000,000	Each Accident
	\$1,000,000	Disease Policy Limit
	\$1,000,000	Disease Each Employee
Comprehensive General Liability	\$2,000,000	Each Occurrence
	\$2,000,000	Aggregate
		<i>(Applicable on a Per Project Basis)</i>
Commercial Automobile Liability	\$1,000,000	Each Accident
Professional Errors & Omissions	\$2,000,000	Each Claim
(pursuant to section 32.9 below)	\$2,000,000	Annual Aggregate
Umbrella Liability	\$ 5,000,000	

32.2 Comprehensive General Liability Insurance required under this paragraph shall be written on an occurrence form and shall include coverage for Products/Completed Operations, Personal Injury with Employment Exclusion (if any) deleted, Blanket XCU and Blanket Contractual Liability insurance applicable to defense and indemnity obligations and other contractual indemnity assumed under the Contract Documents. The limit must be on a "Per Project Basis".

32.3 Commercial Automobile Liability Insurance required under this paragraph shall include coverage for all owned, hired and non-owned automobiles.

Village of Downers Grove

- 32.4 Workers Compensation coverage shall include a waiver of subrogation against the Village.
- 32.5 Comprehensive General Liability, Employers Liability and Commercial Automobile Liability Insurance may be arranged under single policies for full minimum limits required, or by a combination of underlying policies with the balance provided by Umbrella and/or Excess Liability policies.
- 32.6 Contractor and all Subcontractors shall have their respective Comprehensive General Liability (including products/completed operations coverage), Employers Liability, Commercial Automobile Liability, and Umbrella/Excess Liability policies endorsed to add the "Village of Downers, its officers, officials, employees and volunteers" as "additional insureds" with respect to liability arising out of operations performed; claims for bodily injury or death brought against the Village by any Contractor or Subcontractor employees, or the employees of Subcontractor's subcontractors of any tier, however caused, related to the performance of operations under the Contract Documents. Such insurance afforded to the Village shall be endorsed to provide that the insurance provided under each policy shall be *Primary and Non-Contributory*.
- 32.7 Contractor and all Subcontractors shall maintain in effect all insurance coverages required by the Contract Documents at their sole expense and with insurance carriers licensed to do business in the State of Illinois and having a current A. M. Best rating of no less than A- VIII. In the event that the Contractor or any Subcontractor fails to procure or maintain any insurance required by the Contract Documents, the Village may, at its option, purchase such coverage and deduct the cost thereof from any monies due to the Contractor or Subcontractor, or withhold funds in an amount sufficient to protect the Village, or terminate this Contract pursuant to its terms.
- 32.8 All insurance policies shall contain a provision that coverages and limits afforded hereunder shall not be canceled, materially changed, non-renewed or restrictive modifications added, without thirty (30) days prior written notice to the Village. Renewal certificates shall be provided to the Village not less than five (5) days prior to the expiration date of any of the required policies. All Certificates of Insurance shall be in a form acceptable to the Village and shall provide satisfactory evidence of compliance with all insurance requirements. The Village shall not be obligated to review such certificates or other evidence of insurance, or to advise Contractor or Subcontractor of any deficiencies in such documents, and receipt thereof shall not relieve the Contractor or Subcontractor from, nor be deemed a waiver of the right to enforce the terms of the obligations hereunder. The Village shall have the right to examine any policy required and evidenced on the Certificate of Insurance.
- 32.9 If the Work under the Contract Documents includes design, consultation, or any other professional services, Contractor or the Subcontractor shall procure, maintain, and pay for Professional Errors and Omissions insurance with limits of not less than \$2,000,000 per claim and \$2,000,000 annual aggregate. If such insurance is written on a claim made basis, the retrospective date shall be prior to the start of the Work under the Contract Documents. Contractor and all Subcontractors agree to maintain such coverage for three (3) years after final acceptance of the Project by the Village or such longer period as the Contract Documents may require. Renewal policies during this period shall maintain the same retroactive date.

Village of Downers Grove

32.10 Any deductibles or self-insured retentions shall be the sole responsibility of the Insured. At the option of the Village, either: the insurer shall reduce or eliminate such deductibles or self-insured retentions as respects the Village, its officers, officials, employees and volunteers; or the Contractor shall procure a bond guaranteeing payment of losses and related investigations, claim administration and defense expenses.

33. INDEMNITY AND HOLD HARMLESS AGREEMENT

33.1 To the fullest extent permitted by law, the Contractor shall indemnify, keep and save harmless the Village and its agents, officers, and employees, against all injuries, deaths, strikes, losses, damages, claims, suits, liabilities, judgments, costs and expenses, which may arise directly or indirectly from any negligence or from the reckless or willful misconduct of the Contractor, its employees, or its subcontractors.

33.2 The Contractor shall at its own expense, appear, defend and pay all charges of attorneys and all costs and other expenses arising therefrom or incurred in connection therewith, and, if any judgment shall be rendered against the Village in any such action, the Contractor shall, at its own expense, satisfy and discharge the same. This agreement shall not be construed as requiring the Contractor to indemnify the Village for its own negligence. The Contractor shall indemnify, keep and save harmless the Village only where a loss was caused by the negligent, willful or reckless acts or omissions of the Contractor, its employees, or its subcontractors.

34. SUBLETTING OF CONTRACT

34.1 No contract awarded by the Village shall be assigned or any part subcontracted without the written consent of the Village. In no case shall such consent relieve the Contractor from his obligation or change the terms of this Contract.

All approved subcontracts shall contain language which incorporates the terms and conditions of this Contract.

35. TERMINATION OF CONTRACT

35.1 The Village reserves the right to terminate the whole or any part of this Contract, upon written notice to the Contractor, for any reason.

35.2 The Village further reserves the right to terminate the whole or any part of this Contract, upon written notice to the Contractor, in the event of default by the Contractor. Default is defined as failure of the Contractor to perform any of the provisions of this Contract or failure to make sufficient progress so as to endanger performance of this Contract in accordance with its terms. In the event that the Contractor fails to cure the default in the timeframe provided in the notice, and the Village declares default and termination, the Village may procure, upon such terms and in such manner as it may deem appropriate, supplies or services similar to those so terminated. The Village may also contact the issuer of the Performance Bond to complete the Work. The Contractor shall be liable for any excess costs for such similar supplies or services. Any such excess costs incurred by the Village may be set-off against any monies due and owing by the Village to the Contractor.

Village of Downers Grove

36. BILLING AND PAYMENT PROCEDURES

- 36.1 Payment will be made upon receipt of an invoice referencing Village purchase order number. Once an invoice and receipt of materials or service have been verified, the invoice will be processed for payment in accordance with the Village's payment schedule. The Village will comply with the Local Government Prompt Payment Act, 50 ILCS 505/1 et seq., in that any bill approved for payment must be paid or the payment issued to the Contractor within 60 days of receipt of a proper bill or invoice. If payment is not issued to the Contractor within this 60 day period, an interest penalty of 1.0% of any amount approved and unpaid shall be added for each month or fraction thereof after the end of this 60 day period, until final payment is made.
- 36.2 The Village shall review each bill or invoice in a timely manner after its receipt. If the Village determines that the bill or invoice contains a defect making it unable to process the payment request, the Village shall notify the Contractor as soon as possible after discovering the defect pursuant to rules promulgated under 50 ILCS 505/1 et seq. The notice shall identify the defect and any additional information necessary to correct it.
- 36.3 As this Contract is for work defined as a "fixed public work" project under the Illinois Prevailing Wage Act, 820 ILCS 130/2, any contractor or subcontractor is required to submit certified payroll records along with the invoice. No invoice shall be paid without said records.
- 36.4 Please send all invoices to the attention of: Village of Downers Grove, Accounts Payable, 801 Burlington, Downers Grove, IL 60515.

37. COMPLIANCE WITH OSHA STANDARDS

- 37.1 Equipment supplied to the Village must comply with all requirements and standards as specified by the Occupational Safety and Health Act. All guards and protectors as well as appropriate markings will be in place before delivery. Items not meeting any OSHA specifications will be refused.

38. CERCLA INDEMNIFICATION

- 38.1 The Contractor shall, to the maximum extent permitted by law, indemnify, defend, and hold harmless the Village, its officers, employees, agents, and attorneys from and against any and all liability, including without limitation, costs of response, removal, remediation, investigation, property damage, personal injury, damage to natural resources, health assessments, health settlements, attorneys' fees, and other related transaction costs arising under the Comprehensive Environmental Response, Compensation, and Liability Act (CERCLA) of 1980, 42 U.S.C.A. Sec. 9601, et seq., as amended, and all other applicable statutes, regulations, ordinances, and under common law for any release or threatened release of the waste material collected by the Contractor, both before and after its disposal.
- 38.2 If the Contractor encounters any waste material governed by the above Act, it shall immediately notify the Village and stop working in the area until the above requirements can be met.

39. COPYRIGHT or PATENT INFRINGEMENT

- 39.1 The Contractor agrees to indemnify, defend, and hold harmless the Village against any suit, claim, or proceeding brought against the Village for alleged use of any equipment, systems, or services provided by the Contractor that constitutes a misuse of any proprietary or trade secret information or an infringement of any patent or copyright.

Village of Downers Grove

40. BUY AMERICA

- 40.1 The Contractor agrees to comply with 49 U.S.C.5323(j), the Federal Transportation Administration's (FTA) Buy America regulations at 49 C.F.R. Part 661, and any amendments thereto, and any implementing guidance issued by the FTA, with respect to this Contract, when financed by Federal funds (through a grant agreement or cooperative agreement).
- 40.2 As a condition of responsiveness, the Contractor agrees to submit with its Bid submission, an executed Buy America Certificate, attached hereto.

41. CAMPAIGN DISCLOSURE

- 41.1 Any contractor, proposer, bidder or vendor who responds by submitting a bid or proposal to the Village of Downers Grove shall be required to submit with its bid submission, an executed Campaign Disclosure Certificate, attached hereto.
- 41.2 The Campaign Disclosure Certificate is required pursuant to the Village of Downers Grove Council Policy on Ethical Standards and is applicable to those campaign contributions made to any member of the Village Council.
- 41.3 Said Campaign Disclosure Certificate requires any individual or entity bidding to disclose campaign contributions, as defined in Section 9-1.4 of the Election Code (10 ILCS 5/9-1.4), made to current members of the Village Council within the five (5) year period preceding the date of the bid or proposal release.
- 41.4 By signing the bid documents, contractor/proposer/bidder/vendor agrees to refrain from making any campaign contributions as defined in Section 9-1.4 of the Election Code (10 ILCS 5/9-1.4) to any Village Council member and any challengers seeking to serve as a member of the Downers Grove Village Council.

42. GUARANTEE PERIOD

- 42.1 The Contractor shall provide a guarantee in writing covering a minimum period of one (1) year after approval and acceptance of the Work. The Guarantee shall be in such form as the Village may prescribe, unless otherwise noted in the Specifications, and shall be submitted before receiving final payment. If longer guarantees are required, they will be noted in the Special Provisions for this project.

43. SUCCESSORS AND ASSIGNS

- 43.1 The terms of this Contract will be binding upon and inure to the benefit of the parties and their respective successors and assigns; provided, however, that neither party will assign this Contract in whole or in part without the prior written approval of the other. The Contractor will provide a list of key staff, titles, responsibilities, and contact information to include all expected subcontractors.

44. WAIVER OF BREACH OF CONTRACT

- 44.1 The waiver by one party of any breach of this Contract or the failure of one party to enforce at any time, or for any period of time, any of the provisions hereof will be limited to the particular instance and will not operate or be deemed to waive any future breaches of this Contract and will not be construed to be a waiver of any provision except for the particular instance.

Village of Downers Grove

45. CHANGE ORDERS

- 45.1 The contract price is a "not-to-exceed" cost. At any time additional work is necessary or requested, and the not-to-exceed price is increased thereby, all parties must agree to any change, addition or price increase in writing.
- 45.2 Change orders for public works projects which authorize an increase in the contract price that is 50% or more of the original contract price or that authorize or necessitate any increase in the price of a subcontract under the contract that is 50% or more of the original subcontract price must be resubmitted for bidding in the same manner by which the original contract was bid. (50 ILCS 525/1)

46. SEVERABILITY OF INVALID PROVISIONS

- 46.1 If any provisions of this Contract are held to contravene or be invalid under the laws of any state, country or jurisdiction, contravention will not invalidate the entire Contract, but it will be construed as if not containing the invalid provision and the rights or obligations of the parties will be construed and enforced accordingly.

47. GOVERNING LAW

- 47.1 This Contract will be governed by and construed in accordance with the laws of the State of Illinois. Venue is proper only in the County of DuPage for state cases or the Northern District of Illinois for federal cases.

48. NOTICE

- 48.1 Any notice will be in writing and will be deemed to be effectively served when deposited in the mail with sufficient first class postage affixed, and addressed to the party at the party's place of business. Notices shall be addressed to the Village as follows:

Village Manager
Village of Downers Grove
801 Burlington Ave.
Downers Grove, IL 60515

And to the Contractor as designated on the Contract Form.

49. AMENDMENT

- 49.1 This Contract will not be subject to amendment unless made in writing and signed by all parties.

50. COOPERATION WITH FOIA COMPLIANCE

- 50.1 Contractor acknowledges that the Freedom of Information Act may apply to public records in possession of the Contractor or a subcontractor. Contractor and all of its subcontractors shall cooperate with the Village in its efforts to comply with the Freedom of Information Act. 5 ILCS 140/1 et seq.

51. EMPLOYMENT OF ILLINOIS WORKERS ON PUBLIC WORKS ACT

- 51.1 If the work contemplated by this Contract is funded or financed in whole or in part with State Funds or funds administered by the State, Contractor agrees to comply with the terms of the Employment of Illinois Workers on Public Works Act by employing at least 90% Illinois laborers on the project. 30 ILCS 570/1 et seq. Contractor agrees further to require compliance with this Act by all of its subcontractors.

III. GENERAL PROVISIONS

1. STANDARD SPECIFICATIONS

- 1.1 The following standards shall govern the construction of the proposed improvements:
 - 1.1.1 Standard Specifications for Water and Sewer Main Construction in Illinois, Sixth Edition, 2009 (the Water & Sewer Specs.); and
 - 1.1.2 Standard Specifications for Road and Bridge Construction as adopted by the Illinois Department of Transportation, January 1, 2012; along with Supplemental Specifications and Recurring Special Provisions (collectively the "SSRBC") as adopted by the Illinois Department of Transportation, January 1, 2013; and
 - 1.1.3 Water Distribution Specifications, Village of Downers Grove, Illinois, revised March, 2006.
- 1.2 These Contract Documents shall take precedence whenever there are conflicts in the wording or statements made by the above specifications and these Contract Documents.
- 1.3 Unless otherwise referenced herein, Division I of the Water and Sewer Specs and Section 102 and Articles 104.02, 104.03, 104.07, 107.02, 107.27, 107.35, 108.10, 108.11, and 108.12 of the SSRBC are hereby suspended.

2. COOPERATION OF CONTRACTOR

- 2.1 The Contractor will be supplied with a minimum of 2 sets of approved plans and contract assemblies including Special Provisions, one set of which the Contractor shall keep available on the work site at all times. The Contractor shall give the work site constant attention necessary to facilitate the progress thereof, and shall cooperate with the Village in every way possible.
- 2.2 The Contractor shall have on the work site at all times, as the Contractor's agent, a competent English-speaking representative capable of reading and thoroughly understanding the Contract Documents, and thoroughly experienced in the type of work being performed. The representative shall also be capable of receiving instruction from the Village, and shall have full authority to promptly respond to such instruction. He shall be capable of supplying such materials, equipment, tools, labor and incidentals as may be required. The Contractor shall not replace him without prior written notification to the Village.

3. LEGAL REGULATIONS AND RESPONSIBILITY TO THE PUBLIC

- 3.1 Section 107 of the SSRBC shall govern the Contractor's legal regulations and responsibility to the public, with the following additions:
 - 3.1.1 PROJECT SAFETY. Add the following to Article 107.28:
 - 3.1.1.1 The Contractor shall conduct his work in such a manner as to provide an environment consistent with the safety, health and well being of those engaged in the completion of the Work specified in this Contract.

Village of Downers Grove

- 3.1.1.2 The Contractor shall comply with all State and Federal Safety Regulations as outlined in the latest revisions of the Federal Construction Safety Standards (Series 1926) and with applicable provisions and/or regulations of the Occupation Safety and Health Administration (OSHA) and Standards of the Williams-Stelger Occupational Health Safety Act of 1970 (Revised). **SPECIAL ATTENTION SHALL BE PAID TO COMPLIANCE WITH OSHA'S SUBPART P – EXCAVATIONS STANDARD.**
- 3.1.1.3 The Contractor and Village shall each be responsible for their own respective agents and employees.
- 3.1.2 **BACKING PRECAUTIONS.** Pursuant to Sections 14-139(b) and 14-171.1 of the Downers Grove Municipal Code, any motor vehicle which has an obstructed view to the rear and is to be operated at any time in reverse gear on the public streets of the Village by the Contractor or any subcontractor shall either be equipped with a reverse signal alarm (backup alarm) audible above and distinguishable from the surrounding noise level, or shall provide an observer to signal that it is safe to back up.
- 3.1.3 **OVERWEIGHT, OVERWIDTH AND OVERHEIGHT PERMITS.** The Village has and supports an overweight truck enforcement program. Contractors are required to comply with weight requirements and safety requirements as established by Illinois Law or Village Ordinance, for vehicles, vehicle operators and specialty equipment. In some instances, specialty equipment for road repairs or construction projects requires the movement of overweight, overwidth, or overheight loads utilizing a Village roadway. Such movement will require obtaining a permit from the Village Police Department's Traffic Supervisor.
- 3.1.4 **BARRICADES AND WARNING SIGNS.** The Contractor shall provide the Village with a telephone number of a person or company who is available 24 hours per day, seven days per week, to erect additional barricades or signs. If the Village or its representative deems it necessary for the Public's safety to erect additional barricades or signs during normal working hours, the Contractor will furnish the necessary barricades or signs, and have them in place within 30 minutes. If, after normal working hours, the requested signs are not in place within three hours after the request is made, the Village reserves the right to have the barricades and signs erected. The cost of erecting the barricades and signs shall be deducted by the Village from any payments due the Contractor.

4. PROSECUTION AND PROGRESS

- 4.1 Section 108 of the SSRBC shall govern the prosecution and progress of the work, with the following additions:
- 4.1.1 The Contractor shall schedule his work such that all improvements shall be substantially complete by **July 26, 2013**. Substantial completion shall mean all work excluding possible full parkway turf restoration. All disturbed turf areas shall be backfilled and dressed and left in a safe and useable condition conducive to possible foot traffic and to the satisfaction of the Village. The completion date will remain binding throughout the duration of the Contract unless revised in writing by the Village.

Village of Downers Grove

- 4.1.2 The total duration of disturbance for work related to means of public egress through the project site or access to private property (e.g. removal and replacement of curb and gutters, sidewalks, driveway entrances, etc.) must not exceed ten (10) calendar days. The Contractor may use high-early strength concrete, meeting all specifications herein, at his own expense to help meet this requirement.
- 4.1.3 The Contractor shall also make special note of the following work schedule requirements:
- (a) Appendix A - 2013 CALENDAR OF DOWNERS GROVE DOWNTOWN EVENTS.
No work shall occur in the Downtown Business District one (1) day before, or during any scheduled event listed in Appendix A. The Contractor shall plan his work in the Downtown Business District around the scheduled events. No work shall be left open during an event without the written consent of the Engineer. Any work allowed to be left open during an event shall be protected, with temporary access provided, at no cost to the Village.
 - (b) All work, including restoration, shall be completed by no later than August 16, 2013.
- 4.1.4 Should the Contractor fail to complete the work on or before the specified completion dates set forth in Sections 4.1.1, 4.1.2 or 4.1.3, **or should any sidewalk be closed to traffic for more than a period of ten (10) consecutive calendar days**, or within such extended time as may be allowed, the Contractor shall be liable for liquidated damages in accordance with the applicable sections of Article 108.09 of the SSRBC.
- 4.1.5 Prior to commencing construction, a meeting will be held with the Contractor and the Village. Any questions concerning procedures, general conditions, special provisions, plans or specific items related to the project shall be answered and clarified. No Pre-Construction meeting shall be scheduled until submittals, performance bonds, and certificates of insurance are delivered to, and approved by, the Village.
- 4.1.6 Weekly progress meetings may be required by the Village. If required, the Contractor shall have a capable person, such as a site superintendent or project manager, attend such meetings and be prepared to report on the prosecution of the Work according to the progress schedule. The Village reserves the right to require adjustments to scheduling of work.

5. MEASUREMENT AND PAYMENT

- 5.1 Section 109 of the SSRBC shall govern measurement and payment, with the following additions:
- 5.1.1 Modifies Article 109.07 - Partial payments will be made per Section 36 of Part II of this document (Billing and Payment Procedures.)
 - 5.1.2 The Village will require that partial and final affidavits for all labor, materials and equipment used on the Project, be submitted with the partial and final payment requests. Such waivers shall indicate that charges for all labor, materials and equipment used on the project have been paid. Partial waivers from suppliers and subcontractors may be submitted after the first payment to the Contractor, and before the subsequent payment to that which they apply.

Village of Downers Grove

However, partial waivers from the Contractor must accompany the invoice of the payment to which it applies. All final waivers, from all suppliers and subcontractors **MUST** accompany the Contractor's invoice upon submittal for final payment. A sworn statement by the Contractor shall accompany full waivers. Such requirement for full waivers is solely for the benefit of the Village and shall not be construed to benefit any other person. Partial payment for work done shall in no way imply acceptance of the work to that date.

IV. SPECIAL PROVISIONS

The following Special Provisions shall modify, supercede, or supplement the Standard Specifications referred to in Section III - General Provisions.

Where any section, subsection, paragraph, or subparagraph of the Standard Specifications is *supplemented* by any of the following paragraphs, the provisions of such section, subsection, paragraph, or subparagraph shall remain in effect. The Special Provisions shall govern in addition to the particular Standard Specification so supplemented, and not in lieu thereof.

Where any section, subsection, paragraph, or subparagraph of the Standard Specifications is *amended, voided, or superceded* by any of the following paragraphs, any provision of such section, subsection, paragraph, or subparagraph standing unaffected, shall remain in effect. The Special Provisions shall govern in lieu of any particular provision of the Standard Specification so amended, voided, or superceded, and not in addition to the portion changed.

SP-1 GENERAL SCOPE OF WORK

Description: The 2013 REPLACEMENT SIDEWALK PROGRAM shall generally consist of the following:

Base Bid:

- Removal and replacement of approximately:
 - 18,000 square feet of Portland Cement Concrete (PCC) sidewalk;
 - Handicap ramp installation in accordance with the Americans with Disabilities Act;
 - 900 square feet of Colored PCC sidewalk located within the Downers Grove Downtown Business District;
 - 160 square yards of Hot Mix Asphalt (HMA) driveway pavement patching;
 - 10 square yards of PCC driveway pavement;
 - 100 lineal feet of Combination Concrete Curb & Gutter.

All sidewalks are located within the limits of Village of Downers Grove.

Alternate Bid:

- Removal and replacement of approximately 4,060 square feet of historical brick sidewalk pavers.

SP-2 GENERAL CONSTRUCTION REQUIREMENTS

The following general requirements are intended to govern the overall priority for the performance of the work described in this contract. As general requirements, they are not intended to dictate to the Contractor the precise method by which these tasks shall be performed.

All street openings made prior to November 15th shall be fully restored according to the applicable special provisions, and the street reopened to regular traffic upon the availability of hot-mix bituminous concrete. The Contractor shall assume the risk of restoration over those reaches of pipe installed but not yet pressure-tested for pipe integrity.

Village of Downers Grove

If the project requires the phasing of construction, the contractor is to follow the phasing shown in the plan set. Any variations in the phasing plan shown on the plan set must be approved in writing by the Engineer before construction begins. The contractor will not be allowed to proceed to another phase without the approval of the Engineer. **The contractor will receive no additional compensation for constructing the project in phases.**

No more than three hundred linear feet (300 LF) of pavement may be open-cut and closed to use by the motoring public, and access to all individual drives within the current work zone must be restored at the end of each workday, unless a Village-approved phasing plan shows otherwise.

The Contractor shall maintain traffic flow on ALL STREETS during the day in accordance with the applicable special provision. Adequate signing and flagging is of particular importance for safe travel of all residents.

SP-3 COMPLETION DATE

Description: The Contractor shall schedule his work such that all improvements, including restoration, be substantially complete by **July 26, 2013**. Failure to complete the work on time will result in assessment of liquidated damages in accordance with the applicable sections of Article 108.09 of the Standard Specifications.

SP-4 DRIVEWAY ACCESS NOTIFICATION

Description: If access to a driveway will be blocked, the Contractor shall give that resident or business proper written notification at least 24 hours in advance. The Contractor must provide them the opportunity to remove their cars from the driveway or make other arrangements. In addition, the Contractor shall be responsible for notifying the resident or business verbally on the morning of any driveway closure, to ensure awareness of the lack of access.

Samples of written notices shall be submitted to the Engineer for approval before Notice to Proceed is given.

Basis of Payment: This work shall be considered **INCIDENTAL** to the project.

SP-5 TREE PROTECTION

Description: Municipal Codes regarding trees, including tree protection requirements for public parkway trees, are located in Chapter 24 of the Downers Grove Municipal Code. Specifically, Municipal Codes 24-7 and 24-8 detail the public parkway tree protection sizes and fines for violations. The Village Forester shall approve all tree protection measures and any deviations. All tree protection measures and any deviations shall be noted in the contract specifications and on approved project plan sheets and permits using the guidelines listed below.

Tree protection shall include avoiding damage to the above ground tree branches and trunk, and the below ground root system and surrounding soil. Tree crowns and trunks shall not suffer any branch or bark loss. Roots shall be protected from compaction, storage of materials, severing, regrading of the parkway or excavation unless specifically noted on the project plan sheets.

Village of Downers Grove

The Critical Root Zone, or CRZ, is the area immediately surrounding a tree that must be protected from damage. In a municipal parkway setting with utilities and paved or concrete surfaces, the size of the CRZ has been adjusted to form a rectangle around the parkway tree trunk with minimum dimensions listed in the following table. The depth of the CRZ extends to 4 feet below the natural ground surface level.

Parkway <u>Tree diameter at 4.5'</u>	Width street to property <u>(min. curb to sidewalk)</u>	Length along street <u>street(minimum)</u>	<u>Depth</u>
0 – 12.0 inches	10.0 feet	10 feet	4 feet
12.1 – 24.0 inches	10.0 feet	20 feet	4 feet
24.1 or more inches	10.0 feet	30 feet	4 feet

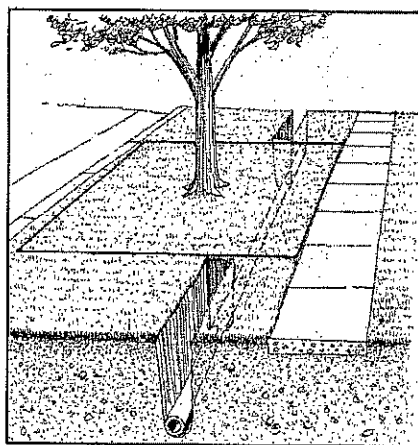

For projects that involve excavations of less than one (1) foot in depth in the parkway or street and are replacing structures in the same location, fencing of the public parkway trees shall not be required. Example projects include, but are not limited to, street pavement resurfacing, curb removal/replacement, driveway removal/replacement, or sidewalk removal/repairs or new sidewalk installations. Contractors shall be mindful of the CRZ dimensions and potential for fines if any parkway trees suffer any unauthorized damage as determined by the Village Forester.

For projects that involve excavations of one (1) foot or more in depth in the parkway or street or both, fencing of the public parkway trees shall be required. Example projects include, but are not limited to, watermain replacements with new roundway keystops and domestic service box installations, sanitary line replacements and new service connections, new or replacement natural gas services, new or replacement phone or fiber optic lines, or new or replacement storm sewers, or projects that widen roads which in turn decreases the parkway soil volume around public parkway trees.

Projects that require fencing (listed above) shall fence the public parkway trees with six (6) foot high chain link construction fence secured to metal posts driven in the ground which are spaced no further than ten (10) feet apart. The dimensions of the fence shall depend on the tree diameter size and shall follow the table listed for the CRZ above, or as large as practical dependent on driveways and other field conditions. The fenced rectangle shall have three (3) sides with the opening facing the adjacent residences for easy access for mowing or tree care. Under no circumstances shall any items be stored within the fence. All fencing shall be maintained daily in an upright good condition. The size and location of all fencing shall be shown on the project plan sheets.

Village of Downers Grove

To avoid damage to the CRZ, utilities must be augered underneath the public parkway trees. Excavation pits for augering equipment are to be outside the fenced area and are to be shown on the project plan sheets. Excavation pits for roundway keystops and domestic service boxes are to be as small as practical with excavation occurring in a direction away from the adjacent public parkway tree.

In cases when severing of roots within a portion of the CRZ may be unavoidable (ex. sidewalk installation, curb replacement, water or sanitary service replacement), subject to the approval of the Village Forester, sharp clean cuts shall be made on root ends to promote wound closure and root regeneration. Root pruning and excavation activities shall occur such that the smallest volume of soil and roots is disturbed, and the locations shall be shown on the project plan sheets.

In addition to fines and citations that may be assessed for violations of any Chapter 24 of the Municipal Code (such as not maintaining fencing around the CRZ or unauthorized removal of protected trees), the contractor may be subject to the following provisions:

- Issuance of an invoice for the value or partial value of the tree lost due to damage to either the above ground or below ground portions of the parkway tree, or unauthorized tree removal.
- Costs of repairs, such as pruning or cabling, or costs for removal of the damaged parkway tree along with the stump if the tree cannot remain in the right-of-way.
- Fines of \$500 for the 1st offense; \$1,000 for the 2nd offense; \$2,500 for the 3rd and subsequent offenses.
- Each day during which a violation continues shall be construed as a separate and distinct offense.

The value or partial value of the tree lost shall be determined by the Village Forester using the most current edition of the Guide for Plant Appraisal (prepared by the Council of Tree & Landscape Appraisers and the International Society of Arboriculture) and the most current edition of the Species Ratings & Appraisal Factors for Illinois (prepared by the Illinois Arborist Association). The total cost determined for the damage shall be deducted from the payments made to the Contractor for the project. Should the Village hire another Contractor or tree service to complete pruning work, these costs shall also be deducted from the payments made to the Contractor.

Basis of Payment: This work shall be considered **INCIDENTAL** to the project.

Tree removal as defined by the standard specifications, which will be paid for separately.

SP-6 TRAFFIC CONTROL, MAINTENANCE OF TRAFFIC, DETOURS (ITEM# 70103900)

Description: This item shall include the furnishing, installing, maintaining, relocating and removing of all traffic control devices and personnel used for the purpose of regulating, warning, or directing traffic during the construction of this project. All traffic control devices used on this project shall conform to the Standard Specifications for Traffic Control Devices and the Illinois Manual on Uniform Traffic Control Devices. No waiving of these requirements will be allowed without prior written approval of the Engineer.

Village of Downers Grove

The Contractor shall protect all workers engaged in the project, and shall provide for safe and convenient public travel by providing adequate traffic control under all circumstances. Such circumstances may include, but not be limited to work performed along the route under construction, road closures for construction operations of any type, or when any section of the road is opened to traffic prior to completion of all work. The Contractor shall ensure that work zone in question is properly signed, barricaded and otherwise marked.

The Contractor will be responsible for the proper location, installation, and arrangement of all traffic control devices during the period of construction. All open excavations shall be protected by Type I barricades equipped with working bi-directional flashing lights at each end of the excavation, as well as at 50-foot intervals between ends for excavations greater than 50 feet in length and weighted down by **one sandbag per each barricade**. All street closures shall be protected by Type III barricades equipped with working bi-directional flashing lights and weighted down by **eight sandbags per each barricade**.

The Contractor shall plan his work so that there will be no open excavations during non-working hours and that all barricades not necessary have been removed from the pavement during non-working hours.

In the event that one direction of vehicular travel must be closed, the Contractor has the option of setting up a detour route or using flaggers (minimum of two) to direct traffic around the work area. The Engineer shall approve proper signing and barricading of the detour route and lane closures, and shall issue written authorization prior to closure.

In the event that both directions of vehicular travel must be closed, the Contractor shall set up a detour route to direct traffic around the work area. The Engineer shall approve proper signing and barricading of the detour route and shall issue written authorization prior to closure.

The Contractor shall maintain his operations in a manner such that traffic flow shall not be substantially impeded during the construction of the proposed improvements. Where traffic must cross open trenches during a given work day, the Contractor shall provide steel plates at street intersections and driveways. Prior to the end of a given work day, the pavement surface shall be temporarily restored. No open excavation may be left overnight or on the weekend without the express written permission of the Engineer.

No street closure shall be permitted without the express written permission of the Engineer. No street closure may exceed 800 linear feet, nor be in effect from Friday night at 4:30PM to Monday morning at 9:00AM. Where it is necessary to establish a temporary detour, all the requirements of the Standard Specifications and MUTCD shall be met.

As the condition and location of the work changes, the Contractor shall maintain all traffic control devices and personnel engaged in traffic control, in a manner that will accommodate the changing particulars of the work at any given time. Advance warnings, detour and directional information and other controls or directions necessary for safe passage of traffic around the work site shall be reviewed and changed, if necessary, to meet the needs of the situation. Signage erected, but not necessary or proper for the situation ahead shall be covered or taken down. Barricading and signage shall be monitored by the Contractor on a daily basis to ensure that it meets the requirements for work zone safety for the conditions of the particular work being performed.

The Contractor shall provide a name and phone number of a responsible party capable of providing emergency service, 24 hours per day, for the duration of the Project.

Basis of Payment: This work shall be paid for at the contract LUMP SUM price for:

TRAFFIC CONTROL, MAINTENANCE OF TRAFFIC, DETOURS,

which price shall be payment in full for the installation and maintenance of proper traffic control to protect the work and public for the duration of the Project.

SP-7 SCHEDULING OF CONSTRUCTION

Description: At all locations, restoration of the driveway and parkway areas shall commence no later than ten (10) days after the concrete is placed. A construction schedule shall be submitted by the Contractor to the Engineer at the scheduled pre-construction meeting. *The Contractor shall only be allowed to conduct his operations in the Downtown Business District (DBD) between the hours of 9:00 a.m. & 3:00 p.m. Monday through Friday. In addition, any and all construction operations in the DBD shall be completed prior to or after the list of events noted in Appendix A of these specifications.*

SP-8 PORTLAND CEMENT CONCRETE SIDEWALK, 5 INCH, SPECIAL (ITEM # 42400430)

Description: This work shall consist of the removal and replacement of existing P.C.C. sidewalk as indicated by location as shown in the contract documents. All P.C.C. and brick sidewalks shall be removed and replaced by methods and with materials in accordance with Articles 424 and 1020.04 of the SSRBC, except as amended herein.

Removal of existing sidewalk shall include saw cutting, disposal of existing concrete, brick, tree roots, bituminous paved sidewalks, and/or bituminous overlayment of existing sidewalks.

Replacement of sidewalk shall include the following:

- a) Placement of four inches (4") of Type B, CA-6 aggregate base course, compacted, at locations where aggregate base is not existent;
- b) Setting of forms such that the maximum longitudinal slope of the finished walk does not exceed 8.33 percent (1 inch in 12 inches) at corner ramp locations only, and the longitudinal slope does not exceed 5.0 percent max elsewhere.
- c) Placement of five inch (5") thick, Class SI Portland Cement Concrete, 6.1 cwt/cy mix, with 6% air entrainment, 3"-5" slump.
NOTE: Sidewalk through driveways, or where subject to vehicular traffic, shall be placed six inch (6") thick to the width specified on the plans or as directed by the Engineer;
- d) Tooling of contraction joints, 3/4-inch radius, 1 inch deep, and 5 feet on center;
- e) Placement of 3/4-inch thick, preformed flexible foam expansion joint filler placed at 100 foot intervals on center, or abutting existing sidewalks, between driveway pavement and sidewalk, between sidewalk accessibility ramps and curbs where the ramp abuts a curb, or at the end of a pour;
- f) Adjustment of all utility structures encountered to proper grade;
- g) Replacement of all traffic control devices or parking meters removed;
- h) Proper curing of all concrete work utilizing methods and materials outlined in Articles 424 and 1022.01 of the SSRBC. ie. Type III AASHTO M 148 (ASTM C309, Type 2, Class A) white pigmented membrane curing compound;
- i) Complete restoration of abutting Hot-Mix Asphalt (HMA) driveways damaged as a result of installation of sidewalk, or where the sidewalk surface is more than 1/2 inch higher or lower than the original grade of the HMA driveway.

Village of Downers Grove

Restoration shall consist of a minimum of eighteen inches either side of the sidewalk; with a minimum of three inch (3") thick HMA Surface Mixture C, N50 (IL 9.5) surface course; and restoration of gravel drives with similar HMA restoration.

- j) Complete restoration of disturbed parkways with approved pulverized topsoil, without stone aggregate, and seed along the back of curb and edges of replaced sidewalk.

NOTE: Placement of concrete shall not be allowed prior to the Engineer inspecting the aggregate base course. PCC sidewalk installed without prior inspection and approval of the aggregate base course will not be accepted for payment.

Basis for Payment: This work shall be paid for at the contract unit price per **SQUARE FOOT** for:

PORTLAND CEMENT CONCRETE SIDEWALK, 5 INCH, SPECIAL,

which price shall be payment in full for the work as specified herein.

SP-9 PORTLAND CEMENT CONCRETE SIDEWALK, 5 INCH, (COLORED)

Description: This work shall include all work included in SP-8 in addition to the following:

- a) Sidewalk sections are located in the Downtown Business District;
- b) Concrete to be "California Finish" finish;
- c) Concrete colorant to be added to cement mix. Concrete colorant shall be "Harvest Wheat" (Product #U16) supplied by Butterfield Color (1-800-282-3388). **Concrete colorant shall be approved by the Engineer before use.**

Framing for tree grate curb by constructing a thickened reinforced sidewalk edge around tree grates shall be incidental to the contract. See detail drawings as shown in the contract documents.

Basis for Payment: This work shall be paid for at the contract unit price per **SQUARE FOOT** for:

PORTLAND CEMENT CONCRETE SIDEWALK, 5 INCH (COLORED),

which price shall be payment in full for the work as specified herein.

SP-10 DETECTABLE WARNINGS (ITEM# 42400800)

Description: This work shall consist of the installation of new detectable warning material. All detectable warnings shall be placed by methods and with materials in accordance with Article 424 and 424.09 of the SSRBC except as amended herein.

Detectable Warning shall consist of the following:

- a) "Armor-Tile" Cast-In-Place Replaceable or equivalent approved by Engineer;
- b) 24" x 60" Brick Red (Federal Color No. 22144) panel;

Basis for Payment: This work shall be paid for at the contract unit price per **SQUARE FOOT** for:

DETECTABLE WARNINGS,

Village of Downers Grove

which price shall include all material, labor, and equipment necessary to complete this item.

SP-11 COMBINATION CONCRETE CURB AND GUTTER REMOVAL AND REPLACEMENT
(ITEM # 44001700)

Description: This work shall consist of the removal and replacement of existing PCC curb and gutter, or the placement of PCC curb and gutter where none exist, of the type, size and location as shown in the contract documents. All PCC curb and gutter shall be removed and replaced by methods and materials as specified in Articles 606 and 1020 of the SSRBC, except as amended herein.

Removal of curb and gutter shall include all necessary saw cutting, excavation, disposal of excess materials, removal of any overlayment of pavement, monolithic underlying base, or brick pavement.

All adjoining driveway pavements and/or sidewalk surfaces and base shall be repaired by methods and approved materials by the Engineer, and shall be considered incidental to combination curb and gutter removal and replacement, unless otherwise noted on the plans.

This work may also include the removal and replacement of existing sections of curb in Village owned parking lots, as well as depressed curb and gutter for handicap ramps as indicated for new sidewalk construction, and where existing sidewalk is removed and replaced at crosswalks.

Placement of PCC combination concrete curb and gutter shall include the following:

- a) Class SI Portland cement concrete, 6.1 cwt/cy mix with 6% air entrainment and three inch (3") slump;
- b) Saw cutting of concrete with two inch (2") deep joints at not more than 15-foot intervals within 24 hours after concrete is placed;
- c) Placement of two (2) smooth, epoxy coated dowel bars into the gutter flag portion of existing concrete curb, and at expansion joints in accordance with the detail shown in the contract documents;
- d) Placement of 3/4 inch pre-molded expansion joint filler perpendicular to the centerline of the roadway:
 - 1) For the full depth of the curb and gutter;
 - 2) Where abutting existing concrete curb and gutter;
 - 3) At five feet (5') on either side of utility structures;
 - 4) At construction joints at ends of pours;
 - 5) At not more than ninety foot (90') intervals.
- e) Proper curing of all concrete work utilizing methods and materials outlined in Articles 424 and 1022.01 of the SSRBC. ie. Type III AASHTO M 148 (ASTM C309, Type 2, Class A) white pigmented membrane curing compound;
- f) Backfilling of all curb work with materials approved by the Engineer;
- g) Excavation for, and the installation of, compacted approved topsoil and seed to a minimum width of eighteen inches (18") from the back of curb, or for width equal to area disturbed by the installation of curb;
- h) Complete restoration of disturbed parkways with approved pulverized topsoil and seed along the back of curb.

All curb and gutter shall be monolithic Type B-6.12 MODIFIED unless otherwise noted in the contract documents.

Village of Downers Grove

Basis for Payment: This work shall be paid for at the contract unit price per FOOT for:

COMBINATION CONCRETE CURB AND GUTTER REMOVAL AND REPLACEMENT,

which price shall be payment in full for the work as specified herein.

SP-12 MANHOLES TO BE ADJUSTED (ITEM # 60255500)

Description: This work shall consist of the adjustment of water valve vault, drainage, traffic signal, street lighting, and sanitary structure frames and grates or covers. All utility structure frames and grates shall be adjusted by the Contractor where necessary to meet the proposed elevation of the new sidewalk surface, or where removal and replacement of existing sidewalk is being performed in order to correct the elevation of the sidewalk relative to the existing utility structure or the existing nominal elevation of the walk on either side of the sidewalk portion to be replaced.

The adjustments to the frames and grates shall be performed at the direction of the Engineer, or representatives of the appropriate utility. The maximum vertical adjustment shall not exceed one foot (1'). Adjustments shall only be made with concrete adjusting rings of a thickness appropriate to the particular adjustment, and shall be secured by mastic joint sealer. Adjustments shall not be made with brick, mortar, wood, or other material.

Basis of Payment: This work shall be paid for at the contract unit price per EACH for:

MANHOLES TO BE ADJUSTED,

which price shall be payment in full for the removal and/or replacement of the existing frame and grate, pre-cast concrete adjusting rings, and compacting and adjusting the grade immediately around the structure.

SP-13 PCC DRIVEWAY REMOVAL AND REPLACEMENT

Description: This work shall consist of the replacement of all PCC driveways that are removed during the course of construction. Driveways shall be replaced to the limits as determined by the maximum width of trench permitted by the Water and Sewer Specifications.

Removal beyond the limitations noted above shall be done only after the Contractor has received written authorization from the Engineer to perform the work.

Replacement of the driveways shall consist of the following:

- a) A transverse saw cut made eighteen inches (18") beyond the edge of the driveway, or as directed by the Engineer;
- b) Shaping and preparing subgrade and slopes adjacent to driveways at all locations accordingly. The maximum grade for the side slopes shall not exceed 33 percent.
- c) Base course consisting of six inches (6") of Type B, CA-6 compacted aggregate base course, measured after placement and compaction.
- d) Surface course consisting of six inches (6") of Class PV PCC.
- e) Proper curing of all concrete work utilizing methods and materials outlined in Articles 424 and 1022.01 of the SSRBC. ie. Type III AASHTO M 148 (ASTM C309, Type 2, Class A) white pigmented membrane curing compound;

Village of Downers Grove

Driveways shall be placed by methods and materials outlined in Articles 423 and 1020.04 of the SSRBC.

Basis of Payment: This work shall be paid for at the contract unit price per SQUARE YARD for:

PCC DRIVEWAY REMOVAL AND REPLACEMENT,

which price shall be payment in full for the work as specified herein.

**SP-14 HOT-MIX ASPHALT DRIVEWAY PAVEMENT, 3" (SPECIAL) (ITEM # Z0004510),
HOT-MIX ASPHALT SIDEWALK TRANSITION, 5"**

Description: Hot-Mix Asphalt Driveway Pavement, 3" (Special) shall consist of the removal and replacement of Hot-Mix Asphalt (HMA) driveways exceeding eighteen inches (18") on either side of the installed sidewalk and the installation of a minimum eighteen inches (18") wide protective asphalt edge on either side of the sidewalk where installation is made through a gravel drive. Removal beyond the limits of incidental asphalt removal and replacement shall be done by the Contractor only at the direction of the Engineer. Said removal shall only be performed in order to adjust the existing driveway so it may meet the grade of the new sidewalk. **This work shall be completed by an IDOT certified asphalt contractor, in accordance with IDOT and Village of Downers Grove public right-of-way specifications.**

Description: Hot-Mix Asphalt Sidewalk Transition, 5" shall consist of installation of an HMA Sidewalk transition between the edge of pavement and concrete sidewalk. This work will be required for all sidewalk ramps adjacent to streets that do not have an existing curb and gutter.

The HMA shall be placed on a minimum of six inches (6") of Type B, CA-6 compacted aggregate base course, consisting of a minimum of two 1½ inch lifts of compacted HMA Surface Mix C, N50 (IL 9.5). HMA shall be placed by methods and materials outlined in Articles 406 and 1009 of the SSRBC. **This work shall be completed by an IDOT certified asphalt contractor, in accordance with IDOT and Village of Downers Grove public right-of-way specifications.** All areas of work shall be properly excavated, prepared, and compacted.

All edges that meet graded parkway areas shall be neatly tamped.

Construction of the sidewalk transition shall include the following:

- a) Excavation as necessary for the full width of the concrete sidewalk;
- b) Placement and compaction of four inches (4") of Type B, CA-6 aggregate base;
- c) Placement and compaction of three inches (3") of HMA Surface, Mix C, N50 (IL 9.5) per the applicable portions of Sec. 442 of the Standard Specifications.

Basis of Payment: This work shall be paid for at the contract unit price per SQUARE YARD for:

HOT-MIX ASPHALT DRIVEWAY PAVEMENT, 3" (SPECIAL)

or

HOT-MIX ASPHALT SIDEWALK TRANSITION, 5",

which price shall be payment in full for the preparation of the area to be paved, proper disposal of excavated and surplus materials, and placement of bituminous concrete materials.

Village of Downers Grove

SP-15 TREE ROOT PRUNING

Description: All trees, public or private, affected by new sidewalk installation within the root protection zone, shall be root pruned prior to any excavation occurring.

Tree root pruning shall be performed in accordance with the Tree Protection Zone detail of the contract documents, and shall be done only to the depth of the excavation necessary for installing the new sidewalk. Root pruning shall start and proceed uninterrupted for the length of travel through the root protection zone. Root pruning shall be made no more than 10 inches from the tree-side edge of the proposed sidewalk.

Approval by the Village Forester of the equipment to be used for tree root pruning, as well as the proposed path of the root pruning work, is required prior to the work being performed. The Engineer or his representative shall permit no excavation until written approval is obtained by the Contractor from the Village Forester. No materials or equipment may be stored or kept in the Tree Protection Zone. Tree damage, as determined by the Village Forester, shall be assessed to the Contractor using the most recent edition of the Guide for Plant Appraisal, published by the International Society of Arboriculture.

Basis of Payment: This work shall be paid for at the contract unit price per **EACH** for:

TREE ROOT PRUNING,

which price shall be payment in full for the work as specified herein and as measured in place.

SP-16 DOMESTIC WATER SERVICE BOXES TO BE ADJUSTED (ITEM # 56500600)

Description: Where encountered, all water service access facilities (buffalo boxes, valve boxes, etc.) shall be adjusted to grade. If needed, the contractor shall be responsible for installing sleeve extensions that match the existing diameter and threading. The Engineer or representative thereof shall approve prior to work.

Basis of Payment: This item shall be paid for at the contract unit price per **EACH** for:

DOMESTIC WATER SERVICE BOXES TO BE ADJUSTED,

which price shall be payment in full for the work as specified herein.

SP-17 DOMESTIC WATER SERVICE BOXES TO BE REPLACED (ITEM # 56500800)

Description: This work shall consist of replacement of domestic water service box using pre-cast concrete support blocks and a buffalo style Tyler 95- E service box. Only cast iron buffalo style boxes and lids are allowed. The cover of the buffalo box shall have the word "WATER" cast thereon.

Basis of Payment: This item shall be paid for at the contract unit price per **EACH** for:

DOMESTIC WATER SERVICE BOXES TO BE REPLACED,

which price shall be payment in full for the work as specified herein.

SP-18 AGGREGATE BASE COURSE, TYPE B, 4"

Description: Aggregate Base Course, Type B, 4" shall meet the requirements of Section 351 and Article 1004.04 of the SSRBC "CA-6" gradation, except that GR-7 gravel shall not be allowed. Aggregate Base Course, Type B, 4" shall be used when under paved areas or structures.

Aggregate Base Course shall be compacted by vibrating plate or other mechanical compacting device in a manner consistent with the Standard Specifications, to ensure that no future settlement occurs.

Existing aggregate base course can be reused if approved by the Engineer. Compacting of reused aggregate base course shall be required.

Basis of Payment: This item shall not be paid for separately but shall be **INCIDENTAL** to:

PORTLAND CEMENT CONCRETE SIDEWALK, 5 INCH, SPECIAL
or
PORTLAND CEMENT CONCRETE SIDEWALK, 5 INCH, (COLORED).

SP-19 EXCAVATION

Description: Costs for all items requiring excavation (i.e. Portland Cement Concrete Sidewalk, Removal and Replacement of Brick Paver Sidewalk, Combination Curb and Gutter Removal and Replacement, and Pipe Drains) shall be **INCIDENTAL** towards implementation of this project. Any/all costs associated with proper disposal of materials shall be borne by the Contractor.

Basis of Payment: No additional compensation will be allowed the Contractor.

SP-20 SAW CUTTING

Description: This work shall consist of saw cutting existing sidewalk along the limits of removal as indicated by the Engineer. Saw cutting shall be full depth for bituminous pavement and 1-1/2 inch depth for concrete through drive approaches for removal of driveway necessary for sidewalk installation for the purpose of delineating sidewalk edges and contraction joints where none currently exist.

Basis of Payment: Saw cutting shall not be paid for separately but shall be **INCIDENTAL** to the contract.

SP-21 SIGN RELOCATE

Description: The Contractor shall remove and relocate all signs located in or near the construction zone as directed by the Engineer. The Contractor shall be responsible for replacing, at his expense, any signs damaged during the course of construction and the operation of removing and relocating any signs.

Basis of Payment: The removal and relocation of all existing signs in or near the construction zone shall not be paid for separately but shall be **INCIDENTAL** to the contract.

SP-22 CLEARING, TREE AND HEDGE REMOVAL

Description: This work shall consist of the removal and disposal of all obstructions encountered during the construction of this improvement. Clearing shall consist of the removal and disposal of all obstructions such as fences, walls, foundations, buildings, accumulations of rubbish of whatever nature and all logs, shrubs, brush, grass, weeds, other vegetation and stumps of less diameter than 6 inches.

Village of Downers Grove

Tree removal shall consist of the cutting, grubbing, removal and disposal of all trees and stumps as hereinafter defined. Hedge removal shall consist of the pulling or grubbing, removal and disposal of all hedge trees or bushes, as hereinafter defined.

A tree shall be defined as a woody, perennial plant having a single main stem or trunk, the diameter of which is 6 inches or more at a point 4 1/2 feet (diameter breast height) above the highest ground level at the tree. Trees with a diameter less than 6 inches will be considered as shrubs. A tree stump with a diameter at cut-off of 6 inches or more will be considered a tree for purposes of measurement and removal. A hedge shall be defined as trees or bushes planted for fence or windbreak purposes in rows containing 20 or more trees or bushes per 100 linear feet.

Rows containing less than 20 trees or bushes per 100 linear feet, and scattered hedge trees or bushes will not be considered a hedge but as trees or shrubs, in accordance with the diameter measurements herein specified.

All trees, stumps, shrubs and bushes designated for removal shall be removed to a depth of not less than 12 inches below the elevation of the sub-grade, the finished earth surface or the ground line. All trees and shrubs designated to be saved shall be protected during clearing and subsequent construction operations.

Overhanging limbs shall be trimmed or cut off to provide a minimum vertical clearance of 7 feet from the finished surface. This shall be considered as clearing. In the event that the Contractor damages any tree or shrub designated to be saved, such plants shall immediately be repaired or replaced as directed by the Engineer in accordance with standard horticultural practice for such work, at the Contractor's expense. Hedge shall not be cut off at the ground level, but shall be pulled or grubbed in such a manner as to ensure complete removal. Scattered hedge trees or shrubs not classified as hedge shall be removed as specified for hedge.

Basis of Payment: Clearing, tree & hedge removal shall not be paid for, but shall be considered **INCIDENTAL** to the contract.

SP-23 REMOVAL AND REPLACEMENT OF BRICK PAVER SIDEWALKS

Description: This work shall consist of removal of existing sidewalk paving bricks, salvaging bricks as necessary, properly disposing of unsalvaged bricks, and replacing with same or similar kind of used brick pavers.

CONSTRUCTION REQUIREMENTS

Brick Sidewalk Paver Removal: The Contractor shall use care to salvage as many of the existing sidewalk bricks as possible for reuse in the brick sidewalk replacement. Visual inspection of existing brick paved sidewalks indicates an anticipated salvage rate of approximately 75%. If the quantity of bricks salvaged is not sufficient to provide a full and complete installation of the new sidewalk in the width specified, any supplemental bricks shall be provided by the Contractor.

Bricks shall be vintage bricks, in a style matching the existing bricks as closely as possible. Three full-size samples shall be provided to the Engineer for approval, along with information regarding the source of the material, a minimum of seven (7) calendar days prior to the start of work. The cost of providing the additional bricks shall be included in the unit price for **REMOVAL AND REPLACEMENT OF BRICK PAVER SIDEWALKS**.

Village of Downers Grove

All bricks not cracked, severely chipped, or broken; clean cut half bricks; or clean cut angled bricks shall be considered salvageable bricks as determined by the Engineer. All bricks deemed unsalvageable shall be properly disposed of by the Contractor.

When salvaging bricks, cleaning foreign material from the salvageable bricks shall be completed before stacking neatly on pallets. Cleaning of the bricks shall be completed as the bricks are removed or anytime before bricks are stacked on pallets. All dirt, sand, mortar, tar, and anything else not considered part of the brick surface shall be removed by hand brushing, wire brush, or trowel, and be promptly removed from the site and legally disposed of by the Contractor. The method of cleaning shall not crack, break, chip, or excessively scar the brick to be salvaged. Bricks shall not be cleaned directly over pavement or grassed areas.

Pallets of salvaged bricks shall be stored onsite in the parkway away from sidewalk, driveways, utilities, and trees or as approved by the Engineer. Pallets may be stacked, but not more than two high and not to obstruct driveway or intersection sight distances. If on site storage is exhausted or if the parkway is too steep, the Contractor shall transport pallets of bricks to 4414 Downers Drive offsite storage facility and back to the project site as necessary. Transportation of bricks shall be included in the cost of this work.

Any brick pavers removed from adjacent brick paved driveways shall be kept separate from the sidewalk paver bricks. The driveway bricks shall be kept on site at or near the driveway from which they were removed. Removal and replacement of driveway brick pavers shall be included in the cost of this work.

Aggregate Base Removal: Necessary removal of the aggregate base to establish the proposed sub-grade shall be completed only after bricks have been removed and shall be included in the cost of this work and completed in accordance with Section 202 of the SSRBC.

Brick Sidewalk Paver Replacement: This work shall be constructed according to current brick paving industry standards and completed by a Contractor experienced in paving brick construction.

This work shall include the following:

- a) Removing the existing brick sidewalk pavers;
- b) Excavating to the sub-surface brick paver thickness plus an additional seven inches (7");
- c) Placement of two inches (2") of Type B, CA-6 aggregate base course graded and compacted with a vibratory walk-behind plate compactor;
- d) Placement of four inch (4") thick, Class SI Portland Cement Concrete base.

NOTE: Portland Cement Concrete base for brick sidewalk pavers through driveways, or where subject to vehicular traffic, shall be placed five inch (5") thick to the width specified or as directed by the Engineer.

- e) Placement of one inch (1") of sand setting bed;
- f) Placement of salvaged bricks or similar kind of used full-size brick pavers of the same or similar color to match existing. The Engineer reserves the right to reject any salvaged bricks that are severely cracked, chipped, or broken.
- g) Filling joints with sand meeting the requirements for ASTM C 144 (mason's sand), with maximum particle size not larger than the joint size (1/8"). Dry sand shall be continually brushed with a broom over the surface until the joints fill flush with the top of the brick pavers.

Village of Downers Grove

- h) Compacting the bricks with a vibratory walk-behind plate compactor with rubber mat compacted to a smooth, even finish.
- i) Complete restoration of abutting Hot-Mix Asphalt (HMA) driveways damaged as a result of installation of sidewalk, or where the sidewalk surface is more than 1/2 inch higher or lower than the original grade of the HMA driveway. Restoration shall consist of a minimum of eighteen inch wide patch on either side of the sidewalk; with a minimum of three inch (3") thick HMA Surface Mixture C, N50 (IL 9.5) surface course; and restoration of gravel drives with similar HMA restoration.
- j) Complete restoration of disturbed parkways with approved pulverized topsoil, without stone aggregate, and seed along the back of curb and edges of replaced sidewalk.

When the joints have been completely brushed and flush with the top of the pavers, the area shall be lightly fogged with water to penetrate the joints. If some settlement in the joint occurs, continue the process until the joint remains flush with the top of the brick paver.

Tolerance: Joint spacing shall not be less than 1/16" nor more than 1/4", but should have an average spacing of 1/8" hand-tight joints.

The maximum variation from plane of brick pavement surface shall be +/- 1-inch in 10 feet. The edges of any two adjacent brick pavers shall not differ by more than 1/8" in height. Brick pavers adjacent to parkway or existing pavement shall not be lower than the top of pavement nor more than 1/4" above it. Cross slope shall not exceed 2%. Longitudinal slope shall not exceed 8.33% (1 inch in 12 inches) at curb ramps, or 5% maximum in non-curb ramp areas. The bond line to which the brick paver pattern is laid shall not vary by more than 2" in 50 feet.

Method of Measurement: This work will be measured for payment of in-place completed brick sidewalk (including soldier course) and computed in square feet.

Basis of Payment: This work shall be paid for at the contract unit price per **SQUARE FOOT** for:

REMOVAL AND REPLACEMENT OF BRICK PAVER SIDEWALKS.

BRICK PAVER SIDEWALK LOCATIONS

STREET NAME	LENGTH (FEET)	WIDTH (FEET)	AREA (SQ FT)
4816 LINS COTT AVE	100	5	500
4811 LINS COTT AVE	65	5	325
648 MAPLE AVE	50	5	250
706 MAPLE AVE	45	5	225
709 MAPLE AVE	45	5	225
720 MAPLE AVE	65	5	325
MAPLE AVE (Historical Museum)	255	7	1,785
4720 MIDD AUGH AVE	50	5	250
4724 MIDD AUGH AVE	35	5	175
TOTAL			4,060

Village of Downers Grove

DOWNTOWN BUSINESS DISTRICT COLORED CONCRETE		Length	Width	Sq Ft
NWX	MAIN ST & MAPLE AVE	6	6	36
5101	MAIN ST	12	4	48
NWX	CURTISS ST & MOCHEL DR	4	4.5	18
		4	4.5	18
933	CURTISS ST	5	4.5	23
		10	4	40
925	CURTISS ST	4	4.5	18
923	CURTISS ST	13.5	4	54
		4.5	4.5	20
1037	CURTISS ST	4.5	4.5	20
		4.5	4.5	20
		4.5	4.5	20
		4.5	4.5	20
5140	MAIN ST	6	3.5	21
		6	5	30
5137	MAIN ST	8	3.5	28
920	CURTISS ST	10	5	50
1030	WARREN AVE	6	5	30
SWX	MAIN ST & WARREN AVE	6	4	24
4946	MAIN ST	6	5	30
		6	5	30
		6	5	30
4930	MAIN ST	5	4.5	23
4900	MAIN ST	5	5	25
SEX	FOREST AVE & WARREN AVE (SE)	10	8	80
NWX	HIGHLAND AVE & WARREN AVE (NW)	10	8	80
965	ROGERS ST	6	4	24
994	WARREN AVE	6	6	36
TOTAL				896

Village of Downers Grove

PCC PLAIN COLOR SIDEWALK LOCATIONS

First Priority Address Locations	Length	Width	Sq Ft
111 39th Street	5	5	25
1430 Acorn Road	20	5	100
2651 Authority Drive	15	5	75
2651 Authority Drive	10	5	50
2655 Authority Drive	45	5	225
2655 Authority Drive	15	5	75
2655 Authority Drive	5	5	25
2655 Authority Drive	5	5	25
2700 Authority Drive	5	5	25
1918 Belle Aire Drive	10	5	50
3800 Belle Aire Drive	10	5	50
3810 Belle Aire Drive	10	5	50
3821 Belle Aire Drive	10	5	50
3841 Belle Aire Drive	10	5	50
4718 Fairview Avenue	5	5	25
2420 Haddow Avenue	5	5	25
3411 Hickory Court	15	5	75
1390 Hickory Court	25	5	125
3421 Hickory Court	5	5	25
1391 Hickory Court	15	5	75
Vacant Lot Hickory Court	5	5	25
SE Corner Lee Avenue	5	5	25
3800 Venard Road	10	5	50
1431 Wood Avenue	5	5	25
1441 Wood Avenue	15	5	75
1461 Wood Avenue	15	5	75
1460 Wood Avenue	15	5	75
1481 Wood Avenue	45	5	225
1500 Wood Avenue	10	5	50
212 3rd Street	10	5	50
334 6th Street	10	5	50
341 6th Street	5	5	25
238 7th St	20	5	100
912 61st St	15	5	75
900 62nd St	10	5	50
912 62nd St	5	5	25
909 62nd Street	5	5	25

Village of Downers Grove

First Priority Address Locations		Length	Width	Sq Ft
1220	67th St	15	5	75
1801	Bolson Dr	15	5	75
6200	Brookbank Road	5	5	25
6040	Brookbank Road	10	5	50
801	Burlington Ave (a.k.a. Village Hall)			
801	Burlington Ave A	9	9	81
801	Burlington Ave B	2	9	18
801	Burlington Ave D	6	6	36
801	Burlington Ave F	27	9	243
801	Burlington Ave G	9	9	81
801	Burlington Ave H	9	9	81
801	Burlington Ave I	2	2	4
801	Burlington Ave J	9	9	81
801	Burlington Ave K	18	9	162
801	Burlington Ave N	9	7	63
801	Burlington Ave Q	2	6	12
801	Burlington Ave R	1	3	3
801	Burlington Ave T	5	5	25
801	Burlington Ave U	5	5	25
801	Burlington Ave V	15	5	75
801	Burlington Ave W	15	5	75
801	Burlington Ave X	5	5	25
801	Burlington Ave Y	5	5	25
801	Burlington Ave Y1	5	5	25
801	Burlington Ave Z	8	8	64
801	Burlington Ave AA	9	9	81
801	Burlington Ave CC	5	5	25
801	Burlington Ave DD	5	5	25
801	Burlington Ave EE	5	5	25
801	Burlington Ave FF	5	5	25
801	Burlington Ave GG	5	5	25
801	Burlington Ave II	5	5	25
7014	Camden Ct	15	5	75
6955	Camden Rd	15	5	75
1230	Chicago Ave	15	5	75
1750	Chicago Ave	20	5	100
4735	Cornell Ave	5	5	25
2500	Curtiss St	5	5	25
2500	Curtiss St	20	5	100
2250	Curtiss St	10	5	50

Village of Downers Grove

First Priority Address Locations		Length	Width	Sq Ft
2400	Curtiss St	20	5	100
		5	5	25
5601	Dearpath Ln	15	5	75
3801	Dillon Ct	35	5	175
4600	Douglas Rd	20	5	100
4323	Douglas Rd	25	5	125
1241	Drove Street	10	5	50
6341	Dunham Rd	10	5	50
5807	Dunham Rd	5	5	25
5837	Dunham Rd	5	5	25
4520	Elm St	50	5	250
4525	Elm St	50	5	250
5313	Fairview Ave	10	5	50
5903	Fairview Ave	10	5	50
5903	Fairview Ave	10	5	50
5905	Fairview Ave	10	5	50
5925	Fairview Ave	15	5	75
5214	Florence Ave	5	5	25
4209	Forest Ave	20	5	100
4213	Forest Ave	10	5	50
4725	Gierz St	15	5	75
1217	Gilbert Ave	15	5	75
1233	Gilbert Ave	20	5	100
1337	Gilbert Ave	40	5	200
1405	Gilbert Ave	5	5	25
1430	Gilbert Ave	5	5	25
1428	Gilbert Ave	15	5	75
1410	Gilbert Ave	15	5	75
1542	Gilbert Ave	10	5	50
1336	Gilbert Ave	5	5	25
1314	Gilbert Ave	5	5	25
1310	Gilbert Ave	5	5	25
1308	Gilbert Ave	10	5	50
1240	Gilbert Ave	15	5	75
1232	Gilbert Ave	20	5	100
1210	Gilbert Ave	5	5	25
1431	Golden Bell Ct	30	5	150
1421	Golden Bell Ct	20	5	100
1800	Hatch St	10	5	50

Village of Downers Grove

First Priority Address Locations		Length	Width	Sq Ft
3827	Highland Ave	15	5	75
4845	Highland Ave	25	5	125
4811	Highland Ave	30	5	150
4429	Highland Ave	5	5	25
4349	Highland Ave	5	5	25
4326	Highland Ave	5	5	25
4334	Highland Ave	25	5	125
4540	Highland Ave	5	5	25
4608	Highland Ave	20	5	100
4616	Highland Ave	25	5	125
4620	Highland Ave	10	5	50
4622	Highland Ave	10	5	50
4628	Highland Ave	10	5	50
4720	Highland Ave	20	5	100
4800	Highland Ave	10	5	50
4804	Highland Ave	10	5	50
4816	Highland Ave	30	5	150
4900	Highland Ave	10	5	50
SE Corner	Highland Ave & Chicago Ave	15	5	75
5709	Hillcrest Ave	15	5	75
5939	Hillcrest Ct	5	5	25
1943	Hitchcock Ave	25	5	125
407	Indianapolis Ave	15	5	75
411	Indianapolis Ave	15	5	75
4417	Highland Ave (across street from 4417 Highland Ave in west parkway adjacent to DG North HS parking lot)	5	5	25
4421	Highland Ave (across street from 4421 Highland Ave in west parkway adjacent to DG North HS parking lot)	10	5	50
4513	Highland Ave (across street from 4513 Highland Ave in west parkway adjacent to AT&T phone Pedestal)	5	5	25
NW Corner	Janet Ave & Belle Aire Dr	10	5	50
4407	Lee Avenue	20	5	100
4713	Lee Avenue	5	5	25
4725	Lee Avenue	15	5	75
*4811	Linscott Ave	65	5	325
*4816	Linscott Ave	100	5	500
1315	Maple Ave	30	5	150
1311	Maple Ave	20	5	100
1307	Maple Ave	5	5	25

Village of Downers Grove

First Priority Address Locations		Length	Width	Sq Ft
1301	Maple Ave	5	5	25
1241	Maple Ave	25	5	125
*648	Maple Ave	50	5	250
*706	Maple Ave	44	5	220
*709	Maple Ave	42	5	210
*720	Maple Ave	63	5	315
*831	Maple Ave	255	7	1,785
6722	Meadowcrest Dr	10	5	50
*4720	Middaugh Ave	49	5	245
*4724	Middaugh Ave	33	5	165
1436	Norfolk St	10	5	50
1530	Ogden Ave	15	5	75
1421	Ogden Ave	20	5	100
7300	Old Main St	20	5	100
2006	Prairie Ave	20	5	100
2050	Prairie Ave	15	5	75
4400	Prospect Ave	20	5	100
1441	Richard St	10	5	50
601	Ridgeview St	19	5	95
1441	Terrace Dr	5	5	25
1401	Thornwood Ave	20	5	100
1525	Thornwood Ave	20	5	100
531	Valley View Dr	25	5	125
3909	Venard Road	40	5	200
3929	Venard Road	20	5	100
3937	Venard Road	25	5	125
3949	Venard Road	25	5	125
4003	Venard Road	15	5	75
NW Corner	Virginia Ave & BellAire Dr	10	5	50
4815	Washington St	45	5	225
7221	Webster St	5	5	25
7310	Webster St	5	5	25
4505	Woodward Ave	10	5	50

*Brick sidewalk

Village of Downers Grove

Second Priority	Address Locations	Length	Width	Sq Ft
626	Chicago Avenue	10	5	50
844	Chicago Avenue	20	5	100
904	Chicago Avenue	10	5	50
5201	Curtiss Street	5	5	25
4622	Douglas Road	15	5	75
4944	Douglas Road	30	5	150
5619	Dunham Road	5	5	25
	Fairview Ave between 60 th and 61 st St across street from vacant lot.	30	5	150
4718	Fairview Avenue	15	5	75
5940	Fairview Avenue	5	5	25
6110	Fairview Avenue	20	5	100
6140	Fairview Avenue	10	5	50
4604	Forest Avenue	25	5	75
4605	Forest Avenue	5	5	25
4640	Forest Avenue	10	5	50
3910	Glendenning Rd	5	5	25
2420	Haddow Avenue	5	5	25
4936	Highland Avenue	5	5	25
4940	Highland Avenue	5	5	25
NE Corner	Highland Avenue & 39th Street	15	5	75
SE Corner	Lee Avenue & Gilbert Avenue	5	5	25
SE Corner	Lee Avenue & Gilbert Avenue (south of Gilbert Avenue)	5	5	25
4340	Prince Street	10	5	50
4540	Prince Street	40	5	200
4644	Prince Street	15	5	75
4516	Sherwood Avenue	10	5	50
802	Warren Avenue	10	5	50
4605	Woodward Avenue	30	5	150

Village of Downers Grove

V. BID and CONTRACT FORM (Village)

*****THIS BID WHEN ACCEPTED AND SIGNED BY AN AUTHORIZED SIGNATORY OF THE VILLAGE OF DOWNERS GROVE SHALL BECOME A CONTRACT BINDING UPON BOTH PARTIES.**

Entire Form Must Be Completed If a Submitted Bid Is To Be Considered For Award

BIDDER:

SCHROEDER & SCHROEDER INC
Company Name

4-17-13
Date

7306 CENTRAL PARK
Street Address of Company

SCHROEDER CONCRETE & PAINTS . COM
E-mail Address

SKOKIE, IL 60076
City, State, Zip

IGNACIO TERRES
Contact Name (Print)

847-933-0526
Business Phone

847-344-0026
24-Hour Telephone

847-933-0528
Business Fax

Signature of Officer, Partner or Sole Proprietor

CHRIS SCHROEDER, PRESIDENT
Print Name & Title

ATTEST: if a Corporation

Signature of Corporation Secretary

We hereby agree to furnish the Village of Downers Grove all necessary materials, equipment, labor, etc. to complete the project within the timeframe specified herein and in accordance with the provisions, instructions and specifications for the unit prices shown on the Schedule of Prices.

VILLAGE OF DOWNERS GROVE:

ATTEST:

Authorized Signature

Village Clerk

Title

Date

Date

In compliance with the specifications, the above-signed offers and agrees, if this Bid is accepted within 90 calendar days from the date of opening, to furnish any or all of the services upon which prices are quoted, at the price set opposite each item, delivered at the designated point within the time specified above.

V. BID and CONTRACT FORM (Contractor)

*****THIS BID WHEN ACCEPTED AND SIGNED BY AN AUTHORIZED SIGNATORY OF THE VILLAGE OF DOWNERS GROVE SHALL BECOME A CONTRACT BINDING UPON BOTH PARTIES.**

Entire Form Must Be Completed If a Submitted Bid Is To Be Considered For Award

BIDDER:

SCHROEDER & SCHROEDER Inc.
Company Name

4-17-13
Date

7306 CENTRAL PARK
Street Address of Company

SCHROEDER.CONCRETE@YAHOO.COM
E-mail Address

SKOKIE, IL 60076
City, State, Zip

IGNACIO TORRES
Contact Name (Print)

847-933-0526
Business Phone

847-344-0026
24-Hour Telephone

847-933-0528
Business Fax

Signature of Officer, Partner or Sole Proprietor

ATTEST: if a Corporation

CHRIS SCHROEDER, PRESIDENT
Print Name & Title

Signature of Corporation Secretary

We hereby agree to furnish the Village of Downers Grove all necessary materials, equipment, labor, etc. to complete the project within the timeframe specified herein and in accordance with the provisions, instructions and specifications for the unit prices shown on the Schedule of Prices.

VILLAGE OF DOWNERS GROVE:

ATTEST:

Authorized Signature

Village Clerk

Title

Date

Date

In compliance with the specifications, the above-signed offers and agrees, if this Bid is accepted within 90 calendar days from the date of opening, to furnish any or all of the services upon which prices are quoted, at the price set opposite each item, delivered at the designated point within the time specified above.

Village of Downers Grove

SCHEDULE OF PRICES:

BASE BID

ITEM NO.	ITEMS	UNIT	QTY	UNIT COST	TOTAL COST
70103900	TRAFFIC CONTROL, MAINTENANCE OF TRAFFIC, DETOURS	LUMP SUM	1	1500 ⁰⁰	1500 ⁰⁰
42400430	PORTLAND CEMENT CONCRETE SIDEWALK, 5 INCH, SPECIAL	SQ FT	18,000	5 ²⁵	94500 ⁰⁰
*N/A	PORTLAND CEMENT CONCRETE SIDEWALK, 5 INCH (COLORED)	SQ FT	900	8 ⁵⁰	7650 ⁰⁰
42400800	DETECTABLE WARNINGS	SQ FT	250	18 ⁰⁰	4500 ⁰⁰
44001700	COMBINATION CONCRETE CURB AND GUTTER REMOVAL AND REPLACEMENT	LIN FT	100	20 ⁰⁰	2000 ⁰⁰
60255500	MANHOLES TO BE ADJUSTED	EACH	7	300 ⁰⁰	2100 ⁰⁰
*N/A	P.C.C. DRIVEWAY REMOVAL AND REPLACEMENT	SQ YD	10	54 ⁰⁰	540 ⁰⁰
Z0004510	HOT-MIX DRIVEWAY PAVEMENT, 3" (SPECIAL)	SQ YD	160	48 ⁰⁰	7680 ⁰⁰
*N/A	HOT-MIX ASPHALT SIDEWALK TRANSITION, 5"	SQ FT	100	7 ⁰⁰	700 ⁰⁰
XX001064	TREE ROOT PRUNING	EACH	20	100 ⁰⁰	2000 ⁰⁰
56500600	DOMESTIC WATER SERVICE BOXES TO BE ADJUSTED	EACH	3	100 ⁰⁰	300 ⁰⁰
56500800	WATER VALVE BOXES TO BE ADJUSTED	EACH	1	125 ⁰⁰	125 ⁰⁰

TOTAL BASE BID 123,595⁰⁰

Village of Downers Grove

ALTERNATE BID

ITEM NO.	ITEMS	UNIT	QTY	UNIT COST	TOTAL COST
42400430	PORTLAND CEMENT CONCRETE SIDEWALK, 5 INCH, SPECIAL (DEDUCT)	SQ FT	(4,060)	8 ⁰⁰	(32,480 ⁰⁰)
	REMOVAL AND REPLACEMENT OF BRICK PAVER SIDEWALKS	SQ FT	4,060	16 ⁰⁰	64,960 ⁰⁰

TOTAL ALTERNATE BID 32,480⁰⁰

TOTAL BID 156,075⁰⁰
 (TOTAL BASE BID + TOTAL ALTERNATE BID)

Village of Downers Grove

BIDDER'S CERTIFICATION (page 1 of 3)

With regard to 2013 SIDEWALK REPLACEMENT, Bidder JEHROSEAN & JEHROSEAN JR.
(Name of Project) (Name of Bidder)

hereby certifies the following:

1. Bidder is not barred from bidding this Contract as a result of violations of Section 720 ILCS 5/33E-3 (Bid Rigging) or 720 ILCS 5/33E-4 (Bid-Rotating);
2. Bidder certifies that it has a written sexual harassment policy in place and full compliance with 775 ILCS 5/2-105(A)(4);
3. Bidder certifies that not less than the prevailing rate of wages as determined by the Village of Downers Grove, DuPage County or the Illinois Department of Labor shall be paid to all laborers, workers and mechanics performing work for the Village of Downers Grove. All bonds shall include a provision as will guarantee the faithful performance of such prevailing wage clause. Bidder agrees to comply with the Illinois Prevailing Wage Act, 820 ILCS 130/1 *et seq.*, for all work completed. Bidder agrees to pay the prevailing wage and require that all of its subcontractors pay prevailing wage to any laborers, workers or mechanics who perform work pursuant to this Contract or related subcontract. Bidder and each subcontractor shall keep or cause to be kept an accurate record of names, occupations and actual wages paid to each laborer, workman and mechanic employed by the Bidder in connection with the contract. This record shall be sent to the Village on a monthly basis along with the invoice and shall be open to inspection at all reasonable hours by any representative of the Village or the Illinois Department of Labor and must be preserved for four (4) years following completion of the contract. Bidder certifies that Bidder and any subcontractors working on the project are aware that filing false payroll records is a Class A misdemeanor and that the monetary penalties for violations are to be paid pursuant to law by the Bidder, contractor and subcontractor. The Village shall not be liable for any underpayments. If applicable: Since this is a contract for a fixed public works project, as defined in 820 ILCS 130/2, Contractor agrees to post at the job site in an easily accessible place, the prevailing wages for each craft or type of worker or mechanic needed to execute the contract or work to be performed;
4. Bidder certifies that it is in full compliance with the Federal Highway Administrative Rules on Controlled Substances and Alcohol Use and Testing, 49 C.F.R. Parts 40 and 382 and that all employee drivers are currently participating in a drug and alcohol testing program pursuant to the Rules;
5. Bidder further certifies that it is not delinquent in the payment of any tax administered by the Department of Revenue, or that Bidder is contesting its liability for the tax delinquency or the amount of a tax delinquency in accordance with the procedures established by the appropriate Revenue Act. Bidder further certifies that if it owes any tax payment(s) to the Department of Revenue, Bidder has entered into an agreement with the Department of Revenue for the payment of all such taxes that are due, and Bidder is in compliance with the agreement.

BIDDER'S CERTIFICATION (page 2 of 3)

BY: *Chris Schroeager*
Bidder's Authorized Agent

36-2908289

FEDERAL TAXPAYER IDENTIFICATION NUMBER

OR _____
Social Security Number

Subscribed and sworn to before me
this 17th day of April, 2013.

Rita Rubin
Notary Public



(Fill Out Applicable Paragraph Below)

(a) Corporation

The Bidder is a corporation organized and existing under the laws of the State of ILLINOIS, which operates under the Legal name of SCHROEAGER & SCHROEAGER INC., and the full names of its Officers are as follows:

President: CHRIS SCHROEAGER

Secretary: Rita Rubin

Treasurer: JOSEPH V. VRABEL

and it does have a corporate seal. (In the event that this bid is executed by other than the President, attach hereto a certified copy of that section of Corporate By-Laws or other authorization by the Corporation which permits the person to execute the offer for the corporation.)

(b) Partnership

Signatures and Addresses of All Members of Partnership:

BIDDER'S CERTIFICATION (page 3 of 3)

The partnership does business under the legal name of: _____
which name is registered with the office of _____ in the state of _____

(c) Sole Proprietor

The Bidder is a Sole Proprietor whose full name is: _____
and if operating under a trade name, said trade name is: _____
which name is registered with the office of _____ in the state of _____

6. Are you willing to comply with the Village's insurance requirements within 13 days of the award of the contract? yes

INSURER'S NAME: CAA

AGENT: MESROW FINANCIAL SERVICES

Street Address: 353 N. CLARK ST.

City, State, Zip Code: CHICAGO, IL 60654

Telephone Number: 312-595-6200

I/We hereby affirm that the above certifications are true and accurate and that I/we have read and understand them.

Print Name of Company: SCHROEDER & SCHROEDER Inc.

Print Name and Title of Authorizing Signature: CHRIS SCHROEDER, PRESIDENT

Signature: 

Date: 4-17-13

MUNICIPAL REFERENCE LIST

Municipality: VILLAGE OF SCHACUMBURG
Address: 101 SCHACUMBURG CT., SCHACUMBURG, IL 60193
Contact Name: JOHN SPENCER Phone #: 773-447-1496
Name of Project: 2012 CONCRETE IMPROVEMENTS
Contract Value: 1,136,620⁰⁰ Date of Completion: FALL 2012

Municipality: VILLAGE OF OAK PARK
Address: 201 SOUTH BLVD, OAK PARK, IL 60302
Contact Name: JIM BERRICK Phone #: 708-358-5727
Name of Project: 2012 SIDEWALK PROGRAM, 2012 ALLEY IMPROVEMENTS
Contract Value: 988,766¹⁸ Date of Completion: FALL 2012

Municipality: VILLAGE OF WINNETKA
Address: 510 GREEN BAY RD, WINNETKA, IL 60093
Contact Name: MEHDI VALI Phone #: 847-716-3530
Name of Project: 2012 SIDEWALK & CURB PROGRAM
Contract Value: 212,489⁷² Date of Completion: SEPT. 2012

Municipality: VILLAGE OF ELK GROVE VILLAGE
Address: 901 WELLINGTON, ELK GROVE VILLAGE, IL 60007
Contact Name: DAVE PRESER Phone #: 847-134-8046
Name of Project: 2012 VILLAGE WIDE CONCRETE REPLACEMENT
Contract Value: 413,583⁸⁴ Date of Completion: OCT 2012

Municipality: VILLAGE OF NORTHBROOK
Address: 655 HUSKIE RD, NORTHBROOK, IL 60062
Contact Name: RICH DACHBERG Phone #: 847-664-4124
Name of Project: 2012 CONCRETE PARKING IMPROVEMENTS
Contract Value: 743,326²⁶ Date of Completion: SEPT 2012

Village of Downers Grove

SUBCONTRACTORS LIST

The Bidder hereby states the following items of work will not be performed by its organization. (List items to be subcontracted as well as the names, addresses and phone numbers of the subcontractors.)

1) _____ Type of Work _____

Addr: _____ City _____ State _____ Zip _____

2) _____ Type of Work _____

Addr: _____ City _____ State _____ Zip _____

3) _____ Type of Work _____

Addr: _____ City _____ State _____ Zip _____

4) _____ Type of Work _____

Addr: _____ City _____ State _____ Zip _____

5) _____ Type of Work _____

Addr: _____ City _____ State _____ Zip _____

6) _____ Type of Work _____

Addr: _____ City _____ State _____ Zip _____

7) _____ Type of Work _____

Addr: _____ City _____ State _____ Zip _____

8) _____ Type of Work _____

Addr: _____ City _____ State _____ Zip _____

Village of Downers Grove



VENDOR W-9 REQUEST FORM

The law requires that we maintain accurate taxpayer identification numbers for all individuals and partnerships to whom we make payments, because we are required to report to the I.R.S all payments of \$600 or more annually. We also follow the I.R.S. recommendation that this information be maintained for all payees including corporations.

Please complete the following substitute W-9 letter to assist us in meeting our I.R.S. reporting requirements. The information below will be used to determine whether we are required to send you a Form 1099. Please respond as soon as possible, as failure to do so will delay our payments.

BUSINESS (PLEASE PRINT OR TYPE):

NAME: SCHROEDER & SCHROEDER Inc.
ADDRESS: 7306 CENTRAL PARK
CITY: SKOKIE
STATE: ILLINOIS
ZIP: 60076
PHONE: 847-933-0526 FAX: 847-933-0528
TAX ID #(TIN): 36-2908289

(If you are supplying a social security number, please give your full name)

REMIT TO ADDRESS (IF DIFFERENT FROM ABOVE):

NAME: _____
ADDRESS: _____
CITY: _____
STATE: _____ ZIP: _____

TYPE OF ENTITY (CIRCLE ONE):

- Individual
- Sole Proprietor
- Partnership
- Medical
- Charitable/Nonprofit
- Limited Liability Company - Individual/Sole Proprietor
- Limited Liability Company-Partnership
- Limited Liability Company-Corporation
- Corporation
- Government Agency

SIGNATURE: *[Handwritten Signature]* DATE: 4-17-13

Village of Downers Grove

Apprenticeship and Training Certification

(Does not apply to federal aid projects. Applicable only to maintenance and construction projects that use Motor Fuel Tax funds or state grant monies.)

Name of Bidder: SCHROEDER & SCHROEDER Inc.

In accordance with the provisions of Section 30-22 (6) of the Illinois Procurement Code, the Bidder certifies that it is a participant, either as an individual or as part of a group program, in the approved apprenticeship and training programs applicable to each type of work or craft that the bidder will perform with its own forces. The Bidder further certifies for work that will be performed by subcontract that each of its subcontractors submitted for approval either (a) is, at the time of such bid, participating in an approved, applicable apprenticeship and training program; or (b) will, prior to commencement of performance of work pursuant to this Contract, begin participation in an approved apprenticeship and training program applicable to the work of the subcontract. The Illinois Department of Labor, at any time before or after award, may require the production of a copy of each applicable Certificate of Registration issued by the United States Department of Labor evidencing such participation by the contractor and any or all of its subcontractors. Applicable apprenticeship and training programs are those that have been approved and registered with the United States Department of Labor. The Bidder shall list in the space below, the official name of the program sponsor holding the Certificate of Registration for all of the types of work or crafts in which the Bidder is a participant and that will be performed with the Bidder's forces. Types of work or craft work that will be subcontracted shall be included and listed as subcontract work. The list shall also indicate any type of work or craft job category that does not have an applicable apprenticeship or training program. **The Bidder is responsible for making a complete report and shall make certain that each type of work or craft job category that will be utilized on the project is accounted for and listed. Return this with the Bid.**

CEMENT MASON AREA JOINT APPRENTICESHIP & CEMENT MASON UNION LOCAL 502

APPRENTICESHIP IN SKILLS IMPROVEMENT PROGRAM LOCAL 150 OPERATORS UNION

CHICAGO LAND LABYRINTH JATC, CAROL STREAM, IL, FOR THE TRADE CONSTRUCTION CRAFT LABOR TEAMSTERS JOINT COUNCIL #25 TRAINING FUND, LOCAL 786
N. IL CEMENT MASON & PLASTER JATC LOCAL 11

The requirements of this certification and disclosure are a material part of the Contract, and the Contractor shall require this certification provision to be included in all approved subcontracts. In order to fulfill this requirement, it shall not be necessary that an applicable program sponsor be currently taking or that it will take applications for apprenticeship, training or employment during the performance of the work of this Contract.

Print Name and Title of Authorizing Signature: Chris Schroeder

Signature: CHRIS SCHROEDER, PRESIDENT

Date: 4-17-13

BUY AMERICA CERTIFICATION

Certification requirement for procurement of steel, iron, or manufactured products when Federal funds (Grant Agreement or Cooperative Agreement) are used.

Instructions:

Bidder to complete the Buy America Certification listed below. Bidder shall certify EITHER COMPLIANCE OR NON-COMPLIANCE (not both). This Certification MUST BE submitted with the Bidder's bid response.

Special Note: Make sure you have signed only one of the above statements – either Compliance OR Non-Compliance (not both).

Certificate of Compliance

The bidder or offeror hereby certifies that it will meet the requirements of 49 U.S.C. 5323(j)(1), as amended, and the applicable regulations in 49 CFR Part 661.

Signature *Chris Schrodde*

Company Name *SCHRODDE & SCHRODDE INC.*

Title *PRESIDENT*

Date *4-17-13*

Certificate of Non-Compliance

The bidder or offeror hereby certifies that it cannot comply with the requirements of 49 U.S.C. 5323(j)(1), as amended, and 49 C.F.R. 661, but it may qualify for an exception pursuant to 49 U.S.C. 5323(j)(2)(A), 5323(j)(2)(B), or 5323(j)(2)(D), and 49 C.F.R. 661.7.

Signature _____

Company Name _____

Title _____

Date _____

AFTER THIS CERTIFICATE HAS BEEN EXECUTED, A BIDDER MAY NOT SEEK A WAIVER.

Note: The U.S./Canadian Free Trade Agreement does not supersede the Buy America requirement.

Suspension or Debarment Certificate

Non-Federal entities are prohibited from contracting with or making sub-awards under covered transactions to parties that are suspended or debarred or whose principals are suspended or debarred. Covered transactions include procurement for goods or services equal to or in excess of \$100,000.00. Contractors receiving individual awards for \$100,000.00 or more and all sub-recipients must certify that the organization and its principals are not suspended or debarred.

By submitting this offer and signing this certificate, the Bidder certifies to the best of its knowledge and belief, that the company and its principals:

1. Are not presently debarred, suspended, proposed for debarment, declared ineligible or voluntarily excluded from covered transactions by any federal, state or local governmental entity, department or agency;
2. Have not within a three-year period preceding this Bid been convicted of or had a civil judgment rendered against them for commission of fraud or a criminal offense in connection with obtaining, attempting to obtain, or performing a public (Federal, State or local) transaction or contract under a public transaction, or convicted of or had a civil judgment against them for a violation of Federal or state antitrust statutes or commission of embezzlement, theft, forgery, bribery, falsification or destruction of records, making false statements, or receiving stolen property;
3. Are not presently indicted for or otherwise criminally or civilly charged by a governmental entity (Federal, State, or local) with commission of any of the offenses enumerated in paragraph (2) of this certification; and
4. Have not within a three-year period preceding this application/proposal/contract had one or more public transactions (Federal, State or local) terminated for cause or default.

If the Bidder is unable to certify to any of the statements in this certification, Bidder shall attach an explanation to this certification.

Company Name: SCHROEDER & SCHROEDER Inc.

Address: 7306 CENTRAL PARK

City: SKOKIE, IL Zip Code: 60076

Telephone: (847) 933-6526 Fax Number: (847) 933-0528

E-mail Address: SCHROEDERCONCRETE@YAHOO.COM

Authorized Company Signature: 

Print Signature Name: CHRIS SCHROEDER Title of Official: PRESIDENT

Date: 4-17-13

CAMPAIGN DISCLOSURE CERTIFICATE

Any contractor, proposer, bidder or vendor who responds by submitting a bid or proposal to the Village of Downers Grove shall be required to submit with its bid submission, an executed Campaign Disclosure Certificate.

The Campaign Disclosure Certificate is required pursuant to the Village of Downers Grove Council Policy on Ethical Standards and is applicable to those campaign contributions made to any member of the Village Council.

Said Campaign Disclosure Certificate requires any individual or entity bidding to disclose campaign contributions, as defined in Section 9-1.4 of the Election Code (10 ILCS 5/9-1.4), made to current members of the Village Council within the five (5) year period preceding the date of the bid or proposal release.

By signing the bid documents, contractor/proposer/bidder/vendor agrees to refrain from making any campaign contributions as defined in Section 9-1.4 of the Election Code (10 ILCS 5/9-1.4) to any Village Council member and any challengers seeking to serve as a member of the Downers Grove Village Council.

Under penalty of perjury, I declare:

Bidder/vendor has not contributed to any elected Village position within the last five (5) years.

Chris Schroeder
Signature

CHRIS SCHROEDER
Print Name

Bidder/vendor has contributed a campaign contribution to a current member of the Village Council within the last five (5) years.

Print the following information:

Name of Contributor: _____
(company or individual)

To whom contribution was made: _____

Year contribution made: _____ Amount: \$ _____

Signature

Print Name

Village of Downers Grove

BID SUBMITTAL CHECKLIST

Each Bidder's Bid Package must be submitted with all requisite forms properly completed, and all documentation included. The following list is not all-inclusive, but is designed to facilitate a good, competitive bidding environment.

1. Instructions to Bidders read and understood. Any questions must be asked according to the instructions.
2. Cover sheet filled-in
3. Bid Form copies filled-in. All copies must have original signatures and seals on them.
4. Bid Bond or cashier's check enclosed with bid package.
5. Schedule of Prices completed. Check your math!
6. Bidder Certifications signed and sealed.
7. Letter from Surety ensuring issuance of Performance and Labor Bonds.
8. Letter from Insurance Agent or Carrier ensuring issuance of required job coverage.
9. Municipal Reference List completed.
10. Vendor request form W-9 completed.
11. Affidavit (IDOT Form BC-57, or similar).
12. Bid package properly sealed and labeled before delivery. If sending by mail or messenger, enclose in a second outer envelope or container. Project plan sheets do not have to be included with the bid package.

APPENDIX A

2013 CALENDAR OF DOWNERS GROVE DOWNTOWN EVENTS

Thursday, March 14 - Saturday, March 16

Spring Open House (Downtown boutiques and restaurants host Spring Open House)

Sunday, April 7

Downers Grove Wedding Walk

Sunday, April 14

Downers Grove Public Library Foundation Mini Golf Event (Indoor Event)

Saturday, May 11 – Saturday, October 19

Downtown Market – Burlington Avenue & Mochel Drive (Every Saturday 6 AM – 2 PM)

Friday, May 17 – Friday, August 30

Summer Nights Classic Car Show – Main Street & Curtiss Street (Every Friday 3 PM – 9 PM)

Monday, May 27

Memorial Day Parade – Main Street

Tuesday, May 28 – Tuesday, August 13

Family Concert Series – Grove Street west of Main Street (Every Tuesday 6:30 PM - 8:30 PM)

Thursday, June 20 – Sunday, June 23

Rotary Grove Fest – Main Street, Curtiss Street, Mochel Drive, Burlington Avenue, Warren Avenue, Highland Avenue

Thursday, July 4 – 12 PM – 2 PM

Independence Day Parade – Main Street

Thursday, July 18 – Sunday, July 21

Downtown Sidewalk Sale – Main Street, Curtiss Street, Burlington Avenue, Washington Street, Mochel Drive, Warren Avenue (Thursday and Friday: 9 AM - 9 PM; Saturday: 9 AM - 5 PM; Sunday: 12 - 4 PM)

Saturday, September 7 – Sunday, September 8

Fine Arts Festival – Main Street, Curtiss Street, Grove Street (All day event)

Thursday, October 3

Girls Night Out – 5 PM – 2 AM

Saturday, October 26

- Helping Girls Navigate Adolescence Breakfast (8 AM – 11 AM @ Ballydoyle Restaurant and Bar)
- Halloween Window Painting - 9 AM - 1 PM

Sunday, October 27

Village of Downers Grove

- Halloween Costume Parade - 12:30 PM - 1:30 PM - Main Street from Burlington Avenue to Grove Street.
- Safe Trick-or-Treating after the parade at the participating downtown merchants.

Thursday, November 29
Bonfield Express 5K Race

Friday, November 29 – Sunday, December 1

- 5th Annual Gingerbread House Contest
- Holiday Tree Lighting - 4:45 PM – Main Street & Burlington Avenue

Sunday, December 1 or Sunday, December 8
Breakfast with Santa – At select restaurants in downtown.

Saturday, November 30

Saturday, December 7, 14, 21

Sunday, December 1, 8, 15, 22

Visits with Santa – Southeast corner of Main Street & Curtiss Street

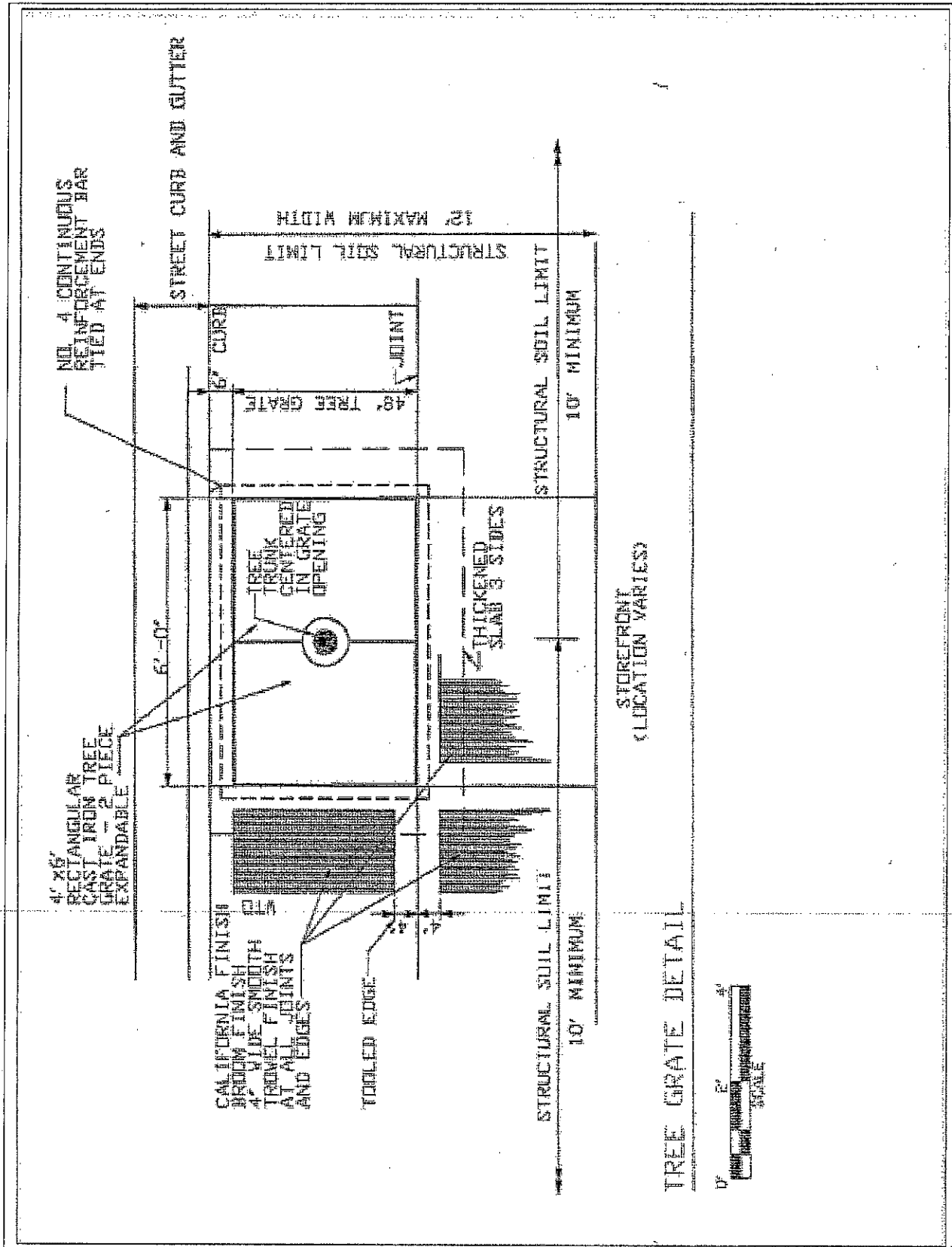

Village of Downers Grove

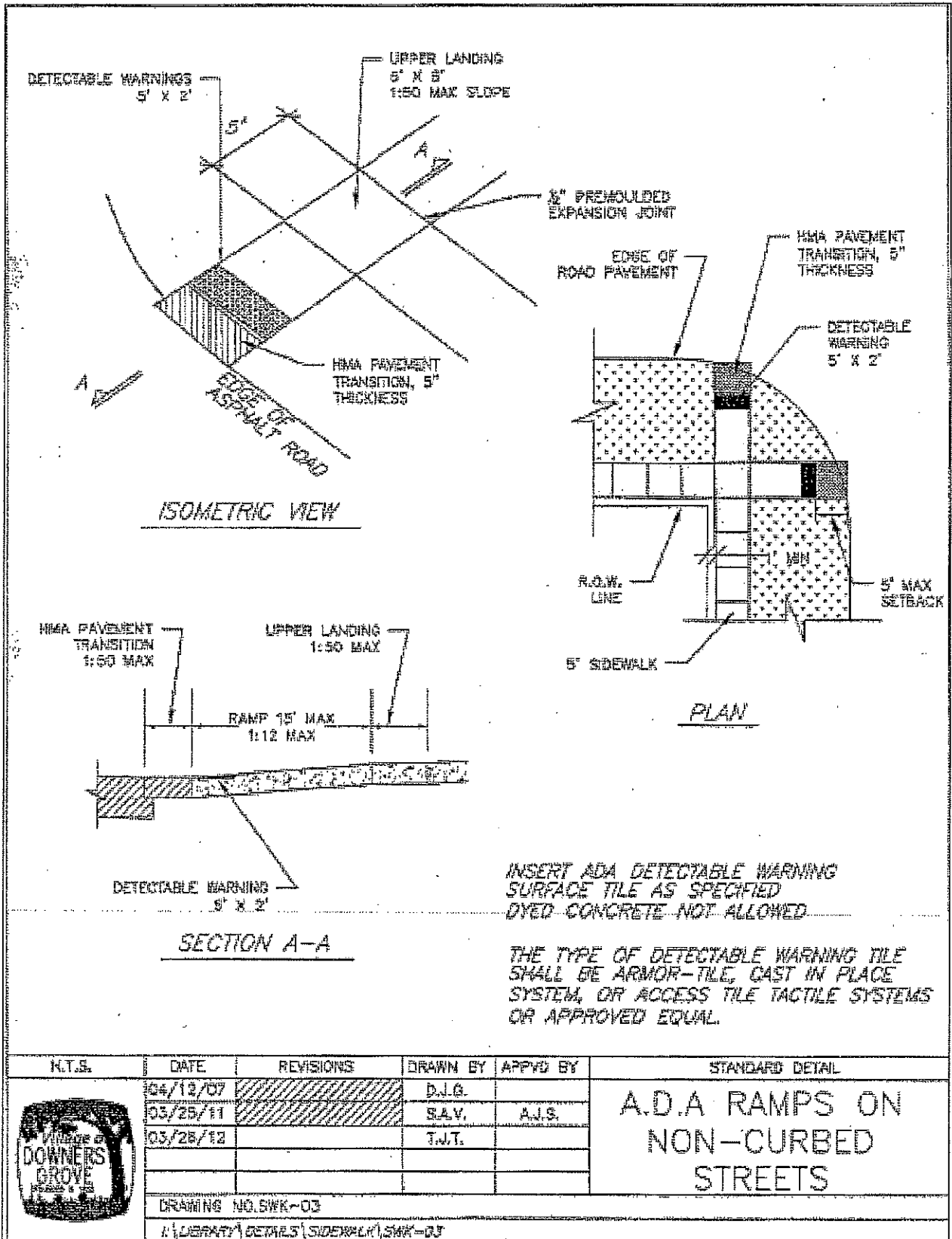

Village of Downers Grove

ALL CONSTRUCTION MATERIALS AND METHODS SHALL COMPLY WITH THE "STANDARDS SPECIFICATION FOR ROAD & BRIDGE CONSTRUCTION" AS ADOPTED BY THE ILLINOIS DEPT. OF TRANSPORTATION UNLESS OTHERWISE SPECIFIED HEREIN

ABSOLUTELY NO CHLORIDE ACCELERANT OR WIRE MESH WILL BE PERMITTED

TYPICAL SIDEWALK PLACEMENT IN R.O.W.

PLACE 1/2" PRE-MOLDED EXPANSION JOINT WHERE ABUTTING EXISTING CONC. BOTH SIDES OF UTILITY STRUCTURE @ EVERY 50' O.C.

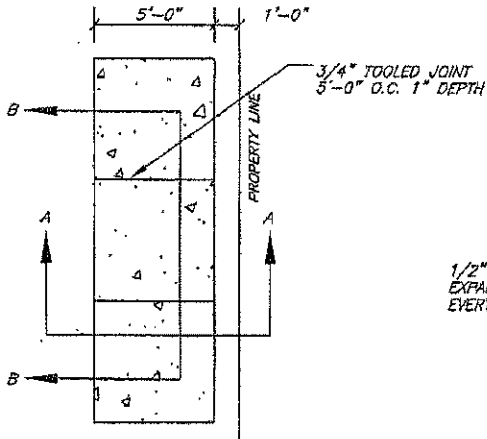

MAX RUNNING SLOPE = 5% (1:20) OR MATCH EXIST GRADE OF THE STREET

1/2" PREMOULD EXPANSION JOINT EVERY 50 FEET

4" COMPACTED CA-6 GRAVEL BASE

SECTION B-B

SAW CUT EXISTING CURB PERPENDICULAR TO BACK 6" FROM EDGE OF WALK UNLESS CUT FALLS WITHIN 5" OF EXIST. JOINT. REMOVE TO EXIST. JOINT. FOR FURTHER DETAILS SEE CURB & GUTTER SPECIFICATIONS

BARRICADING
PLACE TYPE II BARRICADES WITH FLASHING LIGHTS ON ALL SIDES OF EXCAVATIONS. MAINTAIN BARRICADES FOR MIN. 72 HRS AFTER PLACEMENT

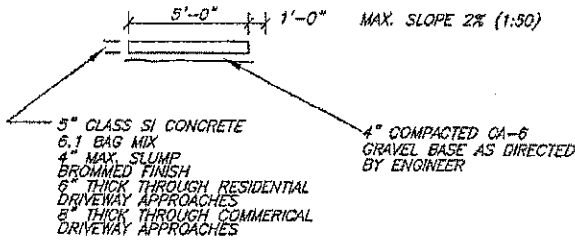

SECTION A-A

N.T.S.	DATE	REVISIONS	DRAWN BY	APPVD BY	STANDARD DETAIL
	02/20/07		D.J.G.		<h1>PUBLIC SIDEWALK</h1>
	03/25/11		S.A.V.	A.J.S.	
	10/10/11		S.A.V.	A.J.S.	
	05/01/12		T.J.T.		
DRAWING NO. SWK-01					
I:\LIBRARY\DETAILS\SIDEWALK\SWK-01					

Village of Downers Grove

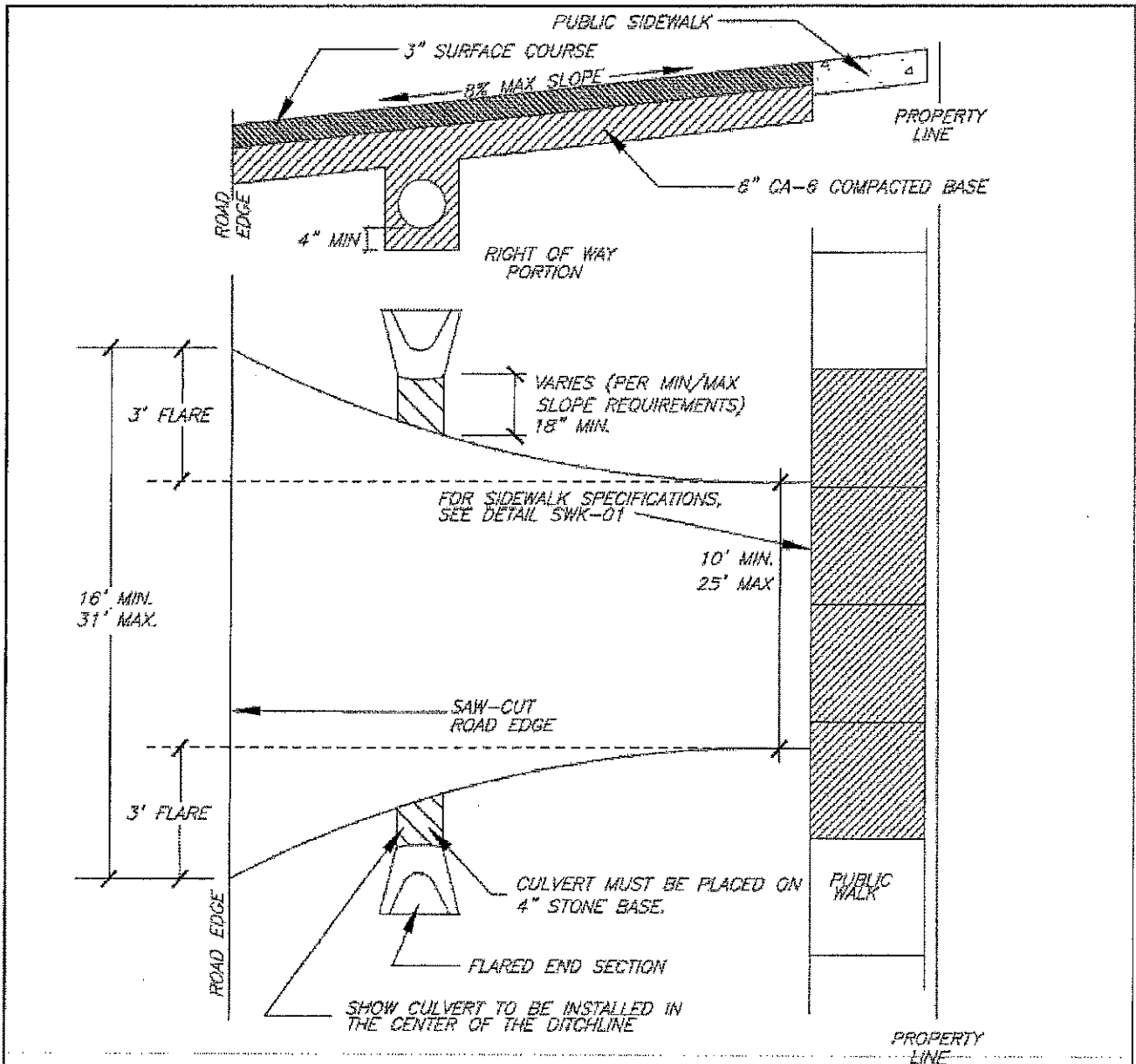

N.T.S.	DATE	REVISIONS	DRAWN BY	APPVD BY	STANDARD DETAIL
	02/20/07		J.M.L.	M.D.M.	ASPHALT APPROACH ON UNIMPROVED ROADWAY
	03/25/11		S.A.V.	A.J.S.	
DRAWING NO. PVT-01					
I:\LIBRARY\DETAILS\PAVEMENT\PVT-01					

Village of Downers Grove

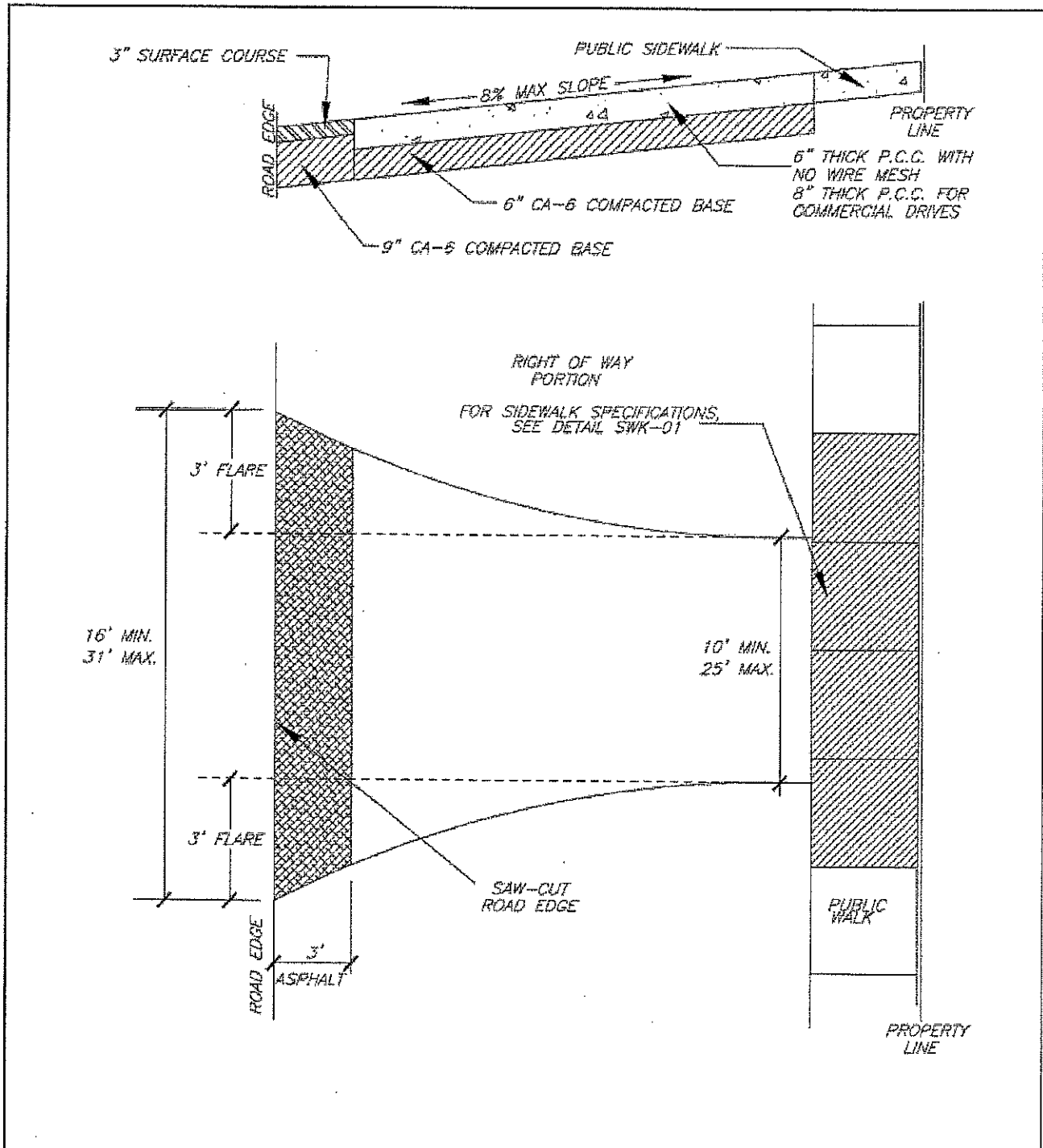

N.T.S.	DATE	REVISIONS	DRAWN BY	APPVD BY	STANDARD DETAIL
	02/20/07		J.M.L.	M.D.M.	CONCRETE APPROACH ON UNIMPROVED ROADWAY
	03/25/11		S.A.V.	A.J.S.	
DRAWING NO. PVT-07					
I:\LIBRARY\DETAILS\PAVEMENT\PVT-07					

BRICK SIDEWALK PAVERS, INSTALLATION/REPLACEMENT

N.T.S.

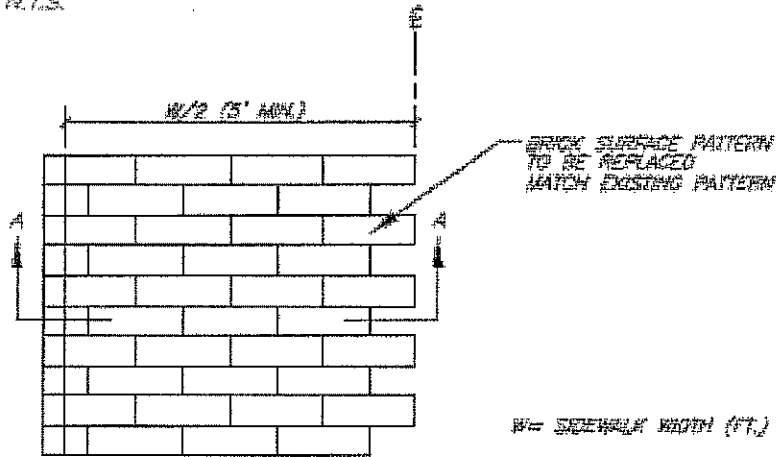

PLAN

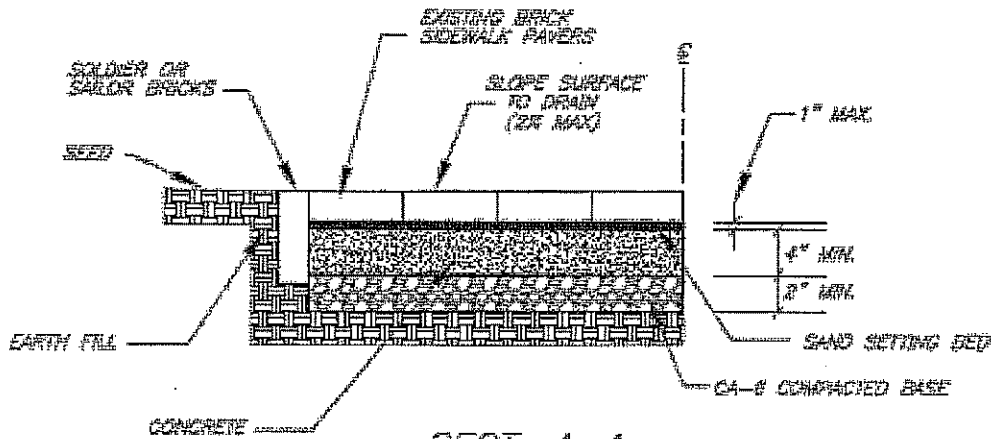

SECT. A-A

- NOTED:
1. REMOVE EXISTING BRICK SIDEWALK PAVERS AND EXCAVATE TO SUBSURFACE BRICK PAVEMENT THICKNESS PLUS 7 INCHES.
 2. COMPACT CA-2 STONE SUB-BASE TO A THICKNESS OF 2" (MINIMUM)
 3. PLACE CONCRETE TO A THICKNESS OF 4" (MINIMUM)
 4. PLACE CONCRETE SAND SETTING BED AND COMPACT WITH A VIBRATING PLATE COMPACTOR TO A MINIMUM THICKNESS OF 1 INCH.
 5. REPLACE/INSTALL BRICK PAVERS AND EDGE PAVERS (SOLDER OR SALON) AND SWEEP JOINTS COMPLETELY FULL WITH SAND.



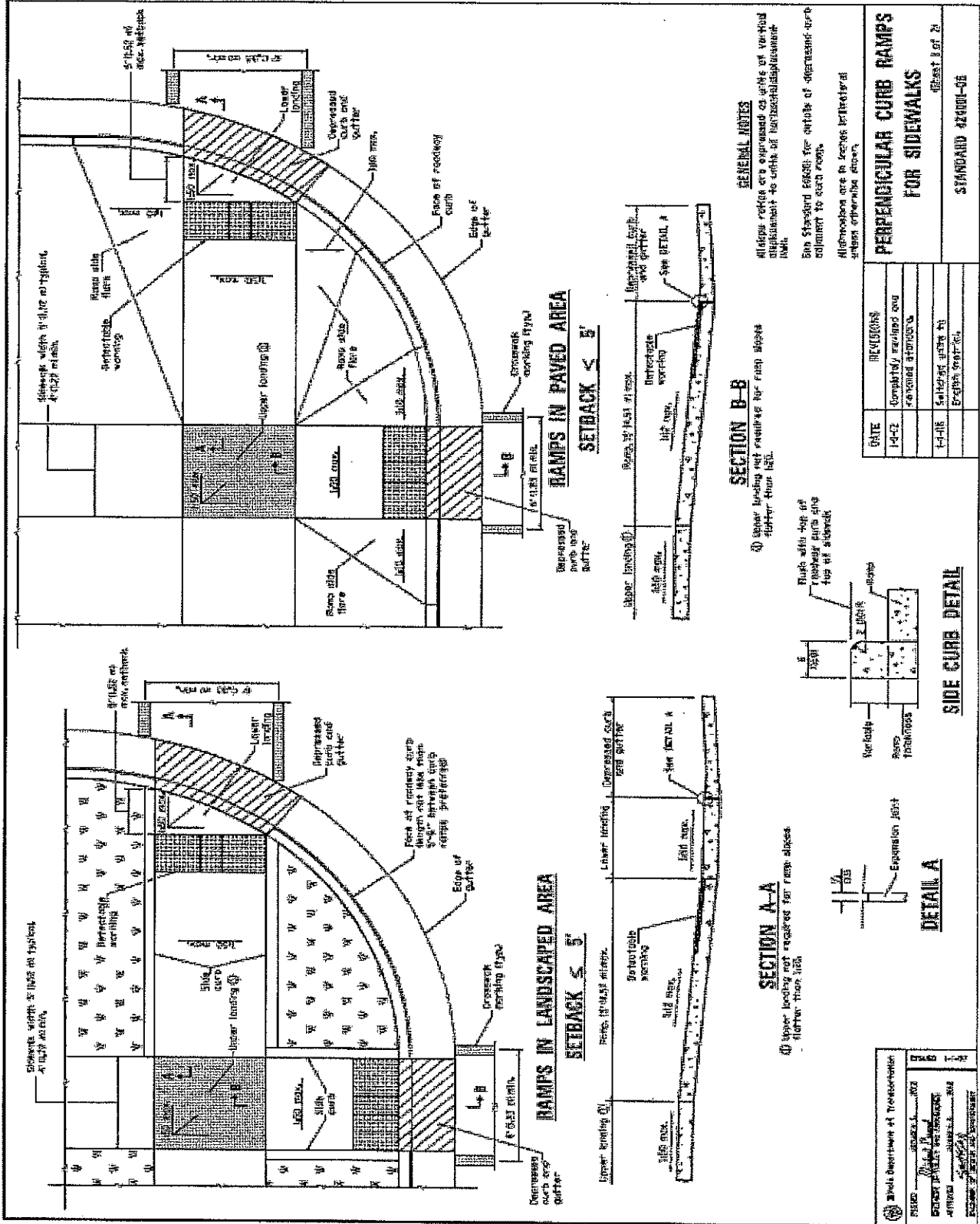

GENERAL NOTES

All slope ratios are expressed as ratio of vertical displacement to units of horizontal displacement.
 See Standard Specifications for details of depressed curb and gutter.
 All dimensions are in feet unless otherwise noted.

SECTION B-B

Upper landing not required for ramp slopes flatter than 1:10.

SECTION A-A

Upper landing not required for ramp slopes flatter than 1:10.

PERPENDICULAR CURB RAMP FOR SIDEWALKS	
Sheet 1 of 2	
DATE	REVISIONS
1-1-02	Complete revised and reworked drawings
1-1-06	Setback, slope of curb and gutter

SIDE CURB DETAIL	
1-1-02	Complete revised and reworked drawings
1-1-06	Setback, slope of curb and gutter

Illinois Department of Transportation
 DESIGN: [Signature]
 CHECKED: [Signature]
 DRAWN: [Signature]
 DATE: [Signature]

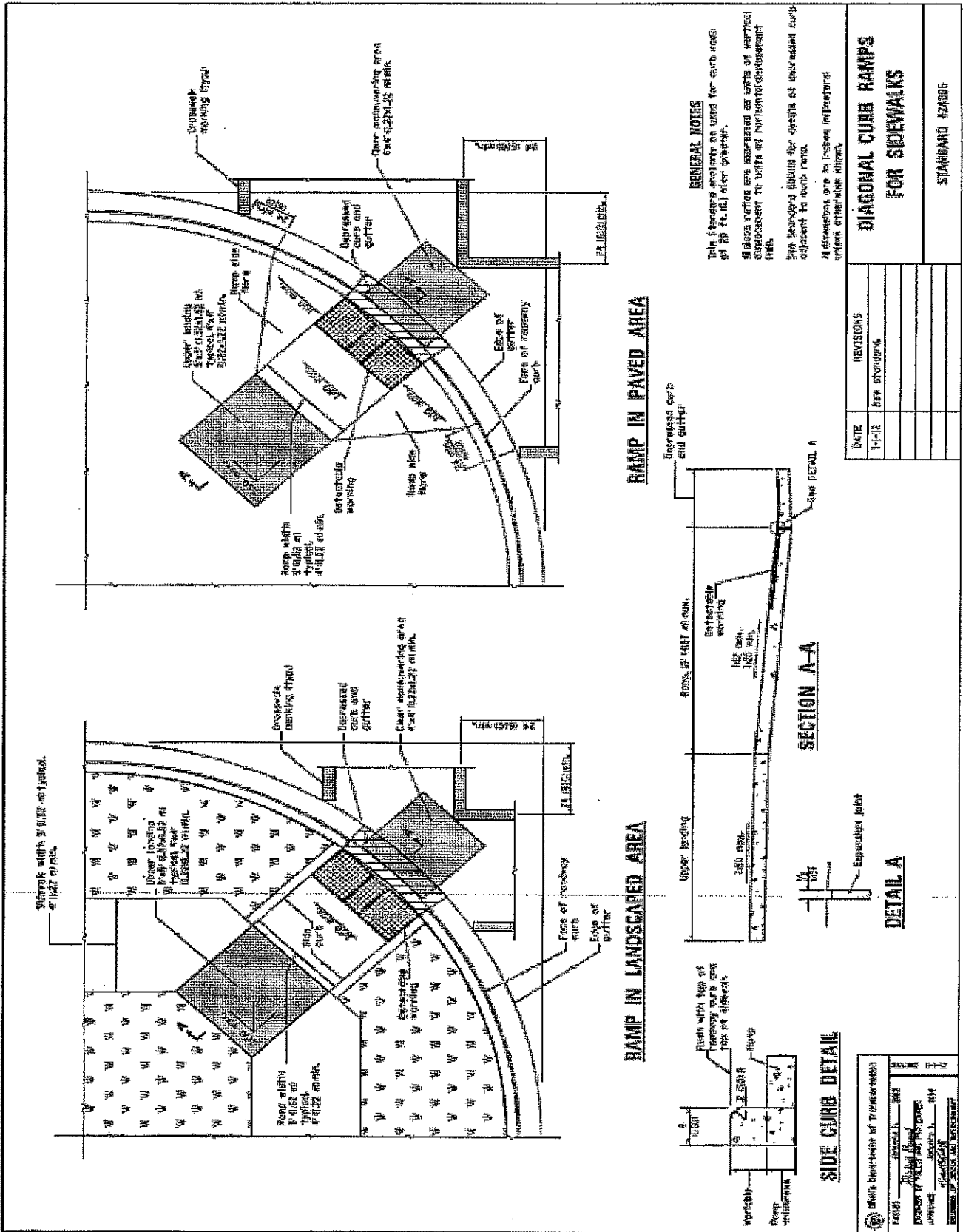

REVISIONS	
DATE	BY
1-1-12	SEE STANDARD

DIAGONAL CURB RAMP FOR SIDEWALKS	
STANDARD 4240R	

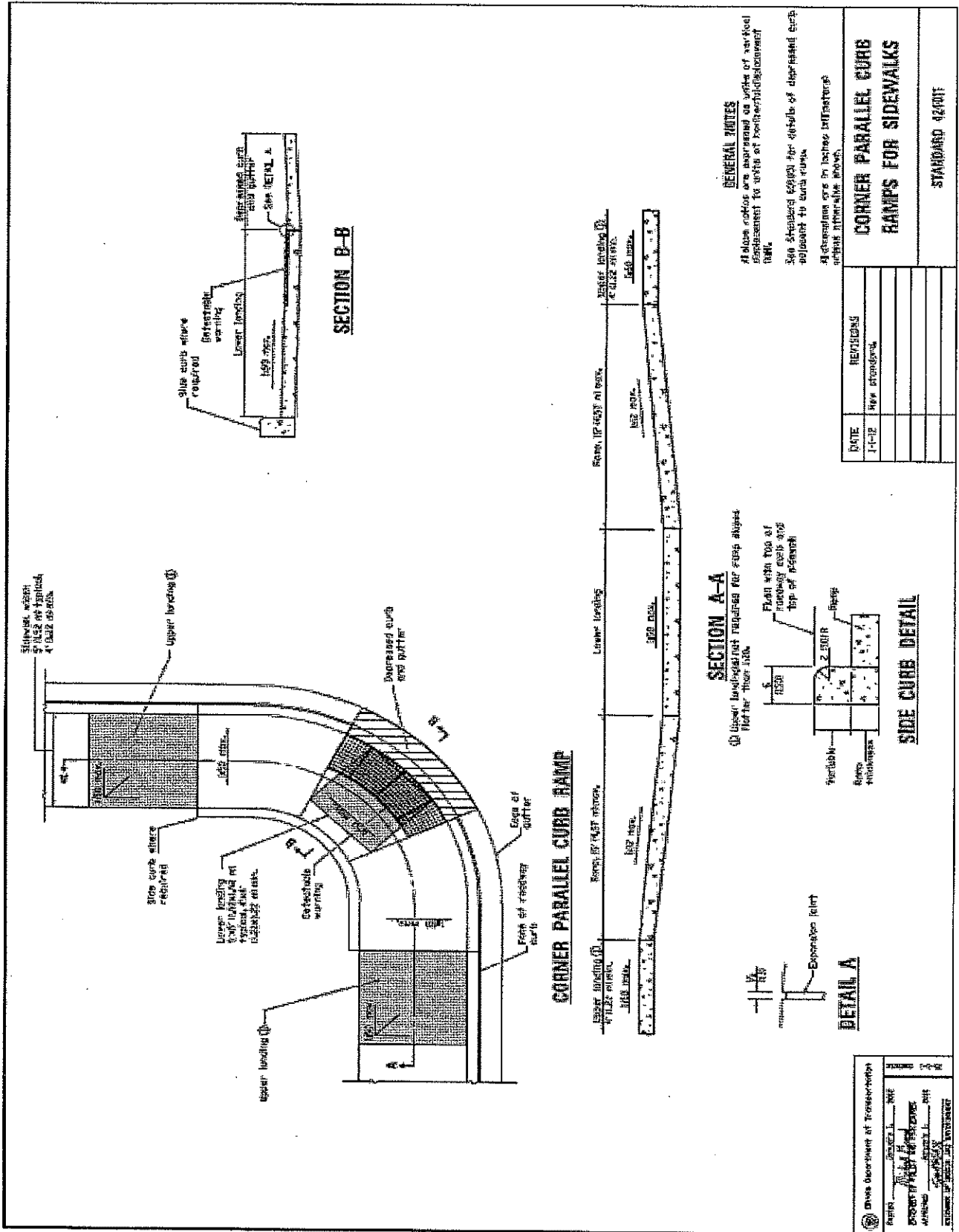

GENERAL NOTES

All elevations are expressed as vertical displacement to grade at centerline of pavement.
 See Standard except for details of depressed curb adjacent to curb curb.
 All dimensions are in inches unless otherwise noted.

SECTION A-A

Upper leveling treatment for curb angles flatter than 1:10.

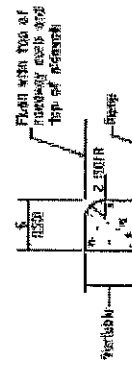

DETAIL A

Flatt with top of roadway curb 3/8\"/>

SIDE CURB DETAIL

DATE	REVISIONS
1-1-12	New standard.

CORNER PARALLEL CURB RAMPS FOR SIDEWALKS

STANDARD 42401T

DIVISION OF TRANSPORTATION
 PROJECT NO. 10-11-11-001
 SHEET NO. 10-11-11-001-011
 DATE 10/11/11
 DRAWN BY J. J. WILSON
 CHECKED BY J. J. WILSON
 APPROVED BY J. J. WILSON

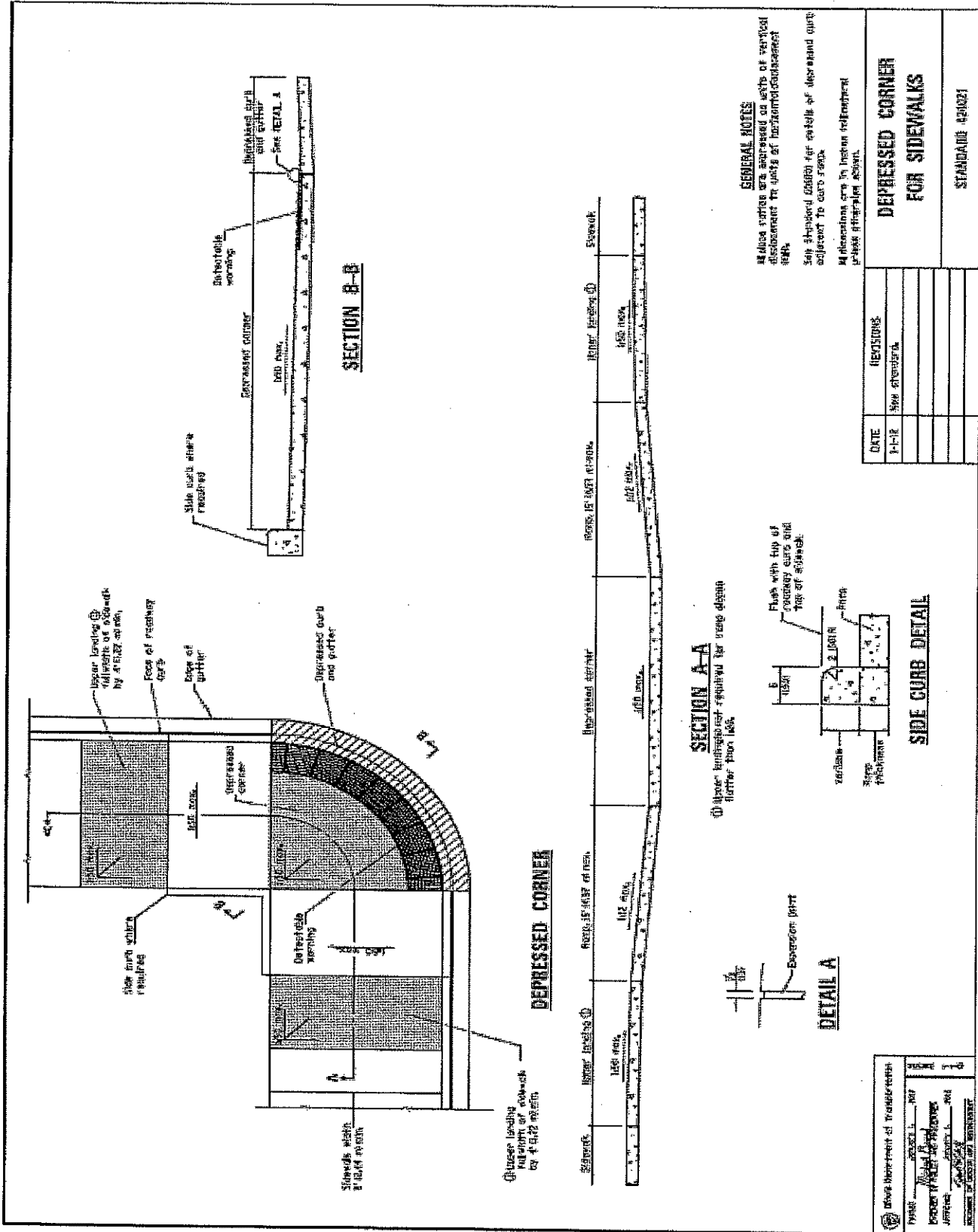

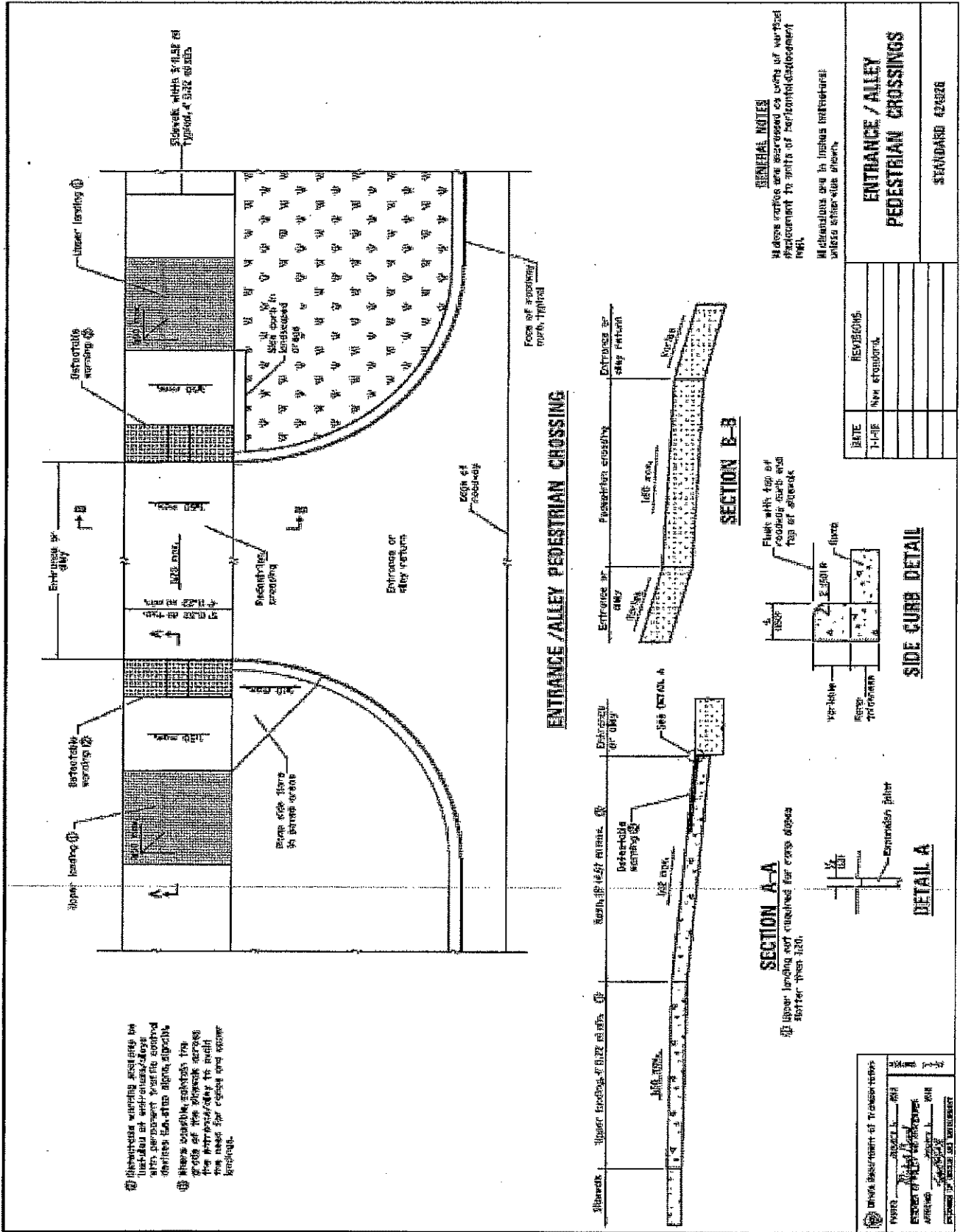

Village of Downers Grove

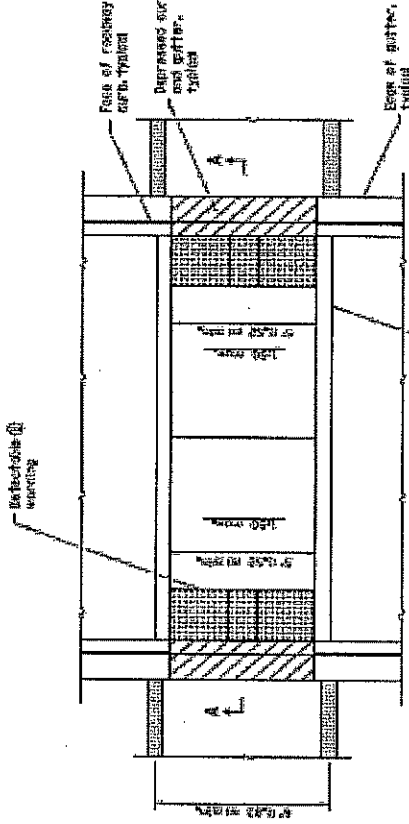

MEDIAN PEDESTRIAN CROSSING

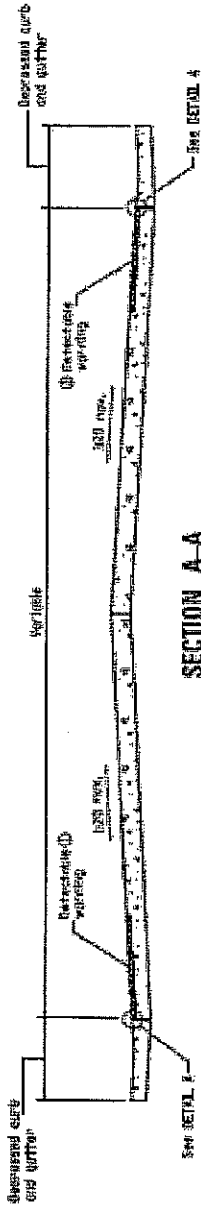
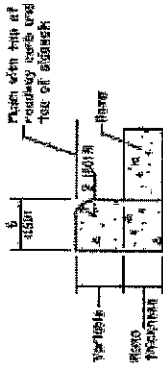

Ø DETECTABLE WARNING SHALL BE LOCATED BETWEEN LANE OF TRAFFIC TO BE LESS THAN 6 FEET.

GENERAL NOTES

1. All work shall be in accordance with the latest edition of the Standard Specifications for Highway Construction, Illinois Department of Transportation, 2013 Edition.

2. See Standard Section for details of depressed curb and gutter.

3. Dimensions are in inches unless otherwise specified.

DATE		REVISIONS	MEDIAN PEDESTRIAN CROSSINGS
11-1-17		Issue standard	
			STANDARD 424031

<p>VILLAGE OF DOWNERS GROVE 1400 N. WILSON AVE. DOWNERS GROVE, ILL. 60120 PHONE: 630.583.1000 FAX: 630.583.1001 WWW: WWW.DOWNERSGROVE.IL.GOV</p>	<p>DATE: 11/1/17 DRAWN BY: J. J. JENSEN CHECKED BY: J. J. JENSEN PROJECT NO.: 17-001 SHEET NO.: 1 OF 1</p>
---	--

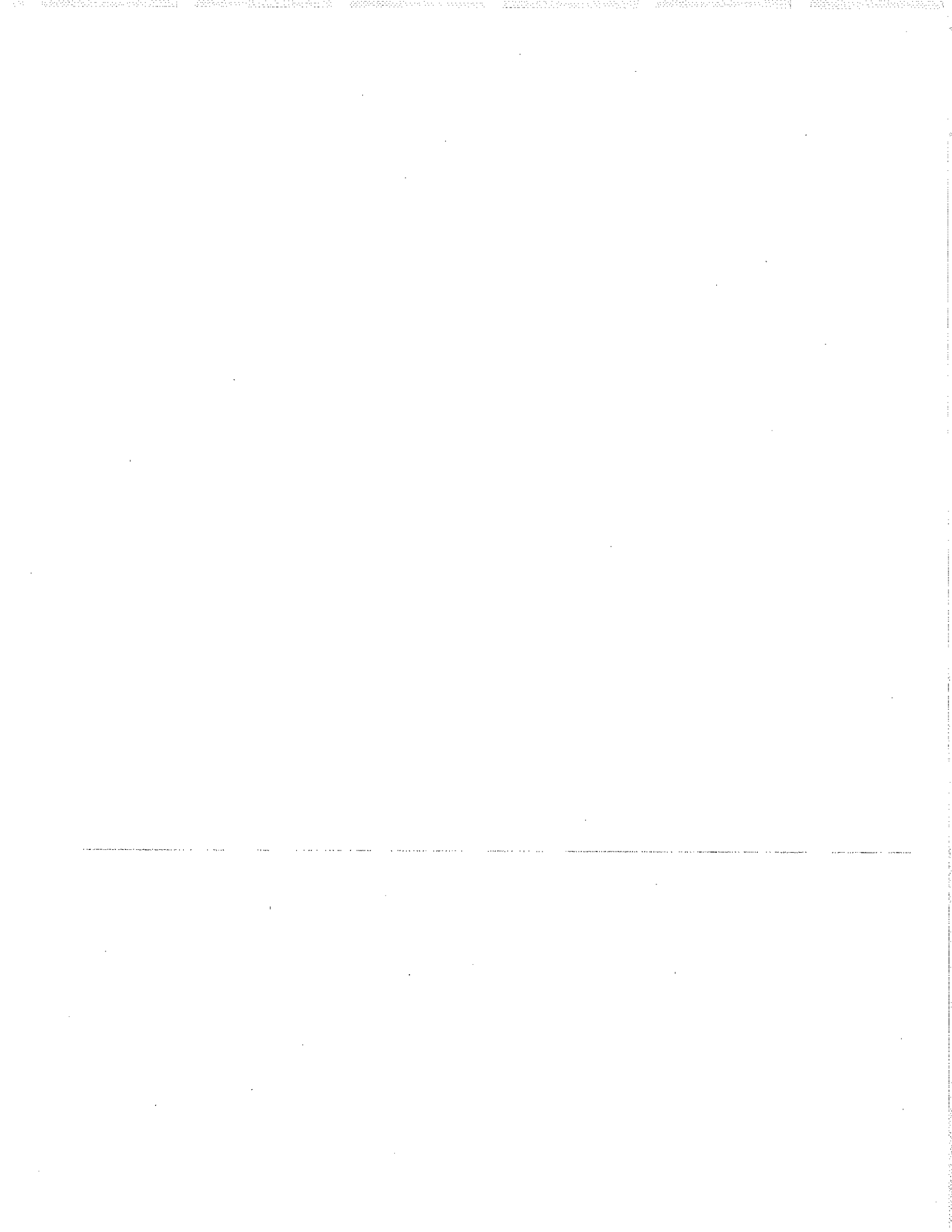

CAMPAIGN DISCLOSURE CERTIFICATE

Any contractor, proposer, bidder or vendor who responds by submitting a bid or proposal to the Village of Downers Grove shall be required to submit with its bid submission, an executed Campaign Disclosure Certificate.

The Campaign Disclosure Certificate is required pursuant to the Village of Downers Grove Council Policy on Ethical Standards and is applicable to those campaign contributions made to any member of the Village Council.

Said Campaign Disclosure Certificate requires any individual or entity bidding to disclose campaign contributions, as defined in Section 9-1.4 of the Election Code (10 ILCS 5/9-1.4), made to current members of the Village Council within the five (5) year period preceding the date of the bid or proposal release.

By signing the bid documents, contractor/proposer/bidder/vendor agrees to refrain from making any campaign contributions as defined in Section 9-1.4 of the Election Code (10 ILCS 5/9-1.4) to any Village Council member and any challengers seeking to serve as a member of the Downers Grove Village Council.

Under penalty of perjury, I declare:

Bidder/vendor has not contributed to any elected Village position within the last five (5) years.

Signature

CHRIS SAMROSOV
Print Name

Bidder/vendor has contributed a campaign contribution to a current member of the Village Council within the last five (5) years.

Print the following information:

Name of Contributor: _____
(company or individual)

To whom contribution was made: _____

Year contribution made: _____ Amount: \$ _____

Signature

Print Name

Village of Downers Grove

V. BID and CONTRACT FORM (Village)

*****THIS BID WHEN ACCEPTED AND SIGNED BY AN AUTHORIZED SIGNATORY OF THE VILLAGE OF DOWNERS GROVE SHALL BECOME A CONTRACT BINDING UPON BOTH PARTIES.**

Entire Form Must Be Completed If a Submitted Bid Is To Be Considered For Award

BIDDER:

SCHROEDER & SCHROEDER INC
Company Name

4-17-13
Date

7306 CENTRAL PARK
Street Address of Company

SCHROEDERCONCRETE@YAHOO.COM
E-mail Address

SKOKIE, IL 60076
City, State, Zip

IGNACIO TORRES
Contact Name (Print)

847-933-0526
Business Phone

847-344-0026
24-Hour Telephone

847-933-0528
Business Fax

Signature of Officer, Partner or Sole Proprietor

ATTEST: if a Corporation

CHRIS SCHROEDER, PRESIDENT
Print Name & Title

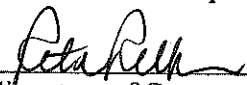
Signature of Corporation Secretary

We hereby agree to furnish the Village of Downers Grove all necessary materials, equipment, labor, etc. to complete the project within the timeframe specified herein and in accordance with the provisions, instructions and specifications for the unit prices shown on the Schedule of Prices.

VILLAGE OF DOWNERS GROVE:

ATTEST:

Authorized Signature

Village Clerk

Title

Date

Date

In compliance with the specifications, the above-signed offers and agrees, if this Bid is accepted within 90 calendar days from the date of opening, to furnish any or all of the services upon which prices are quoted, at the price set opposite each item, delivered at the designated point within the time specified above.

V. BID and CONTRACT FORM (Contractor)

*****THIS BID WHEN ACCEPTED AND SIGNED BY AN AUTHORIZED SIGNATORY OF THE VILLAGE OF DOWNERS GROVE SHALL BECOME A CONTRACT BINDING UPON BOTH PARTIES.**

Entire Form Must Be Completed If a Submitted Bid Is To Be Considered For Award

BIDDER:

SCHROEDER & SCHROEDER JR.
Company Name

4-17-13
Date

7306 CENTRAL PARK
Street Address of Company

SCHROEDER CONCRETE & PAINT CO. INC.
E-mail Address

SKOKIE, IL 60076
City, State, Zip

IGNACIO TORRES
Contact Name (Print)

847-933-0526
Business Phone

847-344-0026
24-Hour Telephone

847-933-0528
Business Fax

Chris Schroeder
Signature of Officer, Partner or Sole Proprietor

ATTEST: if a Corporation
Peta Pell
Signature of Corporation Secretary

CHRIS SCHROEDER, PRESIDENT
Print Name & Title

We hereby agree to furnish the Village of Downers Grove all necessary materials, equipment, labor, etc. to complete the project within the timeframe specified herein and in accordance with the provisions, instructions and specifications for the unit prices shown on the Schedule of Prices.

VILLAGE OF DOWNERS GROVE:

ATTEST:

Authorized Signature

Village Clerk

Title

Date

Date

In compliance with the specifications, the above-signed offers and agrees, if this Bid is accepted within 90 calendar days from the date of opening, to furnish any or all of the services upon which prices are quoted, at the price set opposite each item, delivered at the designated point within the time specified above.



CALL FOR BIDS – FIXED WORKS PROJECT

- I. Name of Company Bidding: SAFE STEP LLC
- II. Instructions and Specifications:
- A. Bid No.: S-006-13
 - B. For: 2013 SIDEWALK REHABILITATION PROJECT
 - C. Bid Opening Date/Time: WEDNESDAY, APRIL 17, 2013 @ 1:00 PM
 - D. Pre-Bid Conference Date/Time: N/A
 - E. Specifications available for pickup at the Public Works Facility, 5101 Walnut Downers Grove, IL. 60515.
- III. Required of All Bidders:
- A. Bid Deposit: 5%
 - B. Letter of Capability of Acquiring Performance Bond: YES
 - C. Certificate of Eligibility from IDOT: YES
- IV. Required of Awarded Contractor(s)
- A. Performance Bond or Letter of Credit: YES
 - B. Certificate of Insurance: YES

Legal Advertisement Published: THURSDAY, APRIL 4, 2013

This document comprises 58 pages

RETURN ORIGINAL BID IN SEALED ENVELOPE MARKED WITH THE BID NUMBER AS NOTED ABOVE TO:

BRIAN PARKS
PROJECT ENGINEER
VILLAGE OF DOWNERS GROVE
5101 WALNUT AVENUE
DOWNERS GROVE, IL 60515
PHONE: 630/434-5460
FAX: 630/434-5495
www.downers.us

Village of Downers Grove

CALL FOR BIDS – FIXED WORKS PROJECT

Bid No.: S-006-13

The VILLAGE OF DOWNERS GROVE will receive bids Monday thru Friday, 8:00 A.M. to 5:00 P.M. at the Public Works Building, 5101 Walnut Avenue, Downers Grove, IL 60515.

The Village Council reserves the right to accept or reject any and all bids, to waive technicalities and to accept or reject any item of any Bid.

The documents constituting component parts of this Contract are the following:

- I. CALL FOR BIDS
- II. TERMS & CONDITIONS
- III. GENERAL PROVISIONS
- IV. SPECIAL PROVISIONS
- V. BID & CONTRACT FORM

All Bidders MUST submit the entire bid package, with one original Bid Form. Upon formal Award, the successful Bid will automatically convert to a Contract, and the successful Bidder will receive a copy of the executed contract upon formal award of the Bid with the Notice of Award.

DO NOT DETACH ANY PORTION OF THIS DOCUMENT. INVALIDATION COULD RESULT.

I. CALL FOR BIDS and INSTRUCTIONS TO BIDDERS

1. GENERAL

- 1.1 Notice is hereby given that Village of Downers Grove will receive sealed bids up to:
WEDNESDAY, APRIL 17, 2013 @ 1:00 PM
- 1.2 Defined Terms:
- 1.2.1 Village – the Village of Downers Grove acting through its officers or agents.
- 1.2.2 Contract Documents – this document plus any drawings issued therewith, any addenda and the Bidder’s completed proposal, bonds and all required certifications.
- 1.2.3 Bid – this document completed by an individual or entity and submitted to the Village.
- 1.2.4 Bidder – the individual or entity who submits or intends to submit a bid proposal to the Village.
- 1.2.5 Contractor – the individual or entity whose bid is selected by the Village and who enters into a contract with the Village.
- 1.2.6 Work – the construction or service defined herein.
- 1.2.7 Day – unless otherwise stated all references to day “Day” “Days”, “day” or “days” shall refer to calendar days.
- 1.2.8 Proposal Guaranty – the required bid deposit.
- 1.3 Bids must be received at the Village by the time and date specified. Bids received after the specified time and date will not be accepted and will be returned unopened to the Bidder.
- 1.4 Bids shall be sent to the Village of Downers Grove, in a sealed envelope marked "SEALED BID". The envelope shall be marked with the name of the project, date, and time set for receipt of Bids. The bid package may be submitted any time prior to the time set for receipt of Bids.
- 1.5 All Bids must be submitted on the forms supplied by the Village and signed by a proper official of the company submitting the Bid. Telephone, email and fax Bids will not be accepted.
- 1.6 Under penalty of perjury, the Bidder certifies by submitting this Bid that he has not acted in collusion with any other Bidder or potential Bidder.

2. BID PREPARATION

- 2.1 It is the responsibility of the Bidder to carefully examine the Contract Documents and to be familiar with all of the requirements, stipulations, provisions, and conditions surrounding the proposed Work.

- 2.2 The Bidder shall inspect the site of the proposed Work in detail, investigate and become familiar with all the local conditions affecting the Work and become fully acquainted with the detailed requirements of the Work. Submitting a Bid shall be a conclusive assurance and warranty that the Bidder has made these examinations and that the Bidder understands all requirements for the performance of the Work. If the Bid is accepted, the Bidder will be responsible for all errors in the Bid resulting from his willing or neglectful failure to comply with these instructions. IN NO CASE WILL THE VILLAGE BE RESPONSIBLE FOR ANY COSTS, EXPENSES, LOSSES OR CHANGES IN ANTICIPATED MARGINS OF PROFIT RESULTING FROM THE WILLING OR NEGLECTFUL FAILURE OF THE BIDDER TO MAKE THESE EXAMINATIONS. THE VILLAGE WILL NOT BE RESPONSIBLE FOR ANY COSTS, EXPENSES, LOSSES OR CHANGES IN ANTICIPATED MARGINS OF PROFIT RESULTING FROM THE WILLING OR NEGLECTFUL FAILURE OF THE CONTRACTOR TO PROVIDE THE KNOWLEDGE, EXPERIENCE AND ABILITY TO PERFORM THE WORK REQUIRED BY THIS CONTRACT. No changes in the prices, quantities or contract provisions shall be made to accommodate the inadequacies of the Bidder, which might be discovered subsequent to award of contract. The Bidder shall take no advantage of any error or omission in the Contract Documents nor shall any error or omission in the Contract Documents serve as the basis for an adjustment of the amounts paid to the Bidder.
- 2.3 When the Contract Documents include information pertaining to subsurface explorations, borings, test pits, and other preliminary investigations, such information is included solely for the convenience of the Bidder. *The Village assumes no responsibility whatsoever with respect to the sufficiency of the information, and does not warrant, neither expressly nor by implication, that the conditions indicated represent those existing throughout the Work, or that unanticipated developments may not occur.*
- 2.4 Any information shown in the Contract Documents regarding the locations of underground utility facilities is included solely for the convenience of the Bidder. The Village assumes no responsibility whatsoever with respect to the sufficiency, accuracy or inadequacy of such information. It shall be the Bidder's responsibility to obtain detailed information from the respective utility companies relating to the location of their facilities and the work schedules of the utility companies for removing or adjusting them. Utilities whose facilities may be affected by the work include, but may not be limited to, the following: Nicor, ComEd, SBC, Comcast Cable, Downers Grove Sanitary District, and Village water, storm sewer, and street lighting systems.
- 2.5 No oral or telephone interpretations of specifications shall be binding upon the Village. All requests for interpretations or clarifications shall be made in writing and received by the Village at least five (5) business days prior to the date set for receipt of Bids or the pre-bid conference, if offered. The Village shall make all changes or interpretations of the Contract Documents in a written addendum and shall provide an addendum to any Bidder of record. Any and all changes to the Contract Documents are valid only if they are included by written addendum to all Bidders. Each Bidder must acknowledge receipt of any addenda by indicating same on the Bid Form. Each Bidder, by acknowledging receipt of any addenda, is responsible for the contents of the addenda and any changes to the Bid therein. Failure to acknowledge any addenda may cause the Bid to be rejected. The Village will not assume responsibility for receipt of any addenda. In all cases, it will be the Bidder's responsibility to obtain all addenda issued. Bidders will provide written acknowledgement of receipt of each addendum issued with the bid submission.

Village of Downers Grove

- 2.6 An estimate of the quantities of Work to be performed and the materials to be furnished is shown in the Bid Form. It is given as a basis for comparing the properly submitted Bids, and shall be used by the Village in awarding the Contract. The Village does not expressly warrant nor imply that the estimated quantities shown will correspond with those quantities required to perform the Work. No Bidder shall plead misunderstanding or deception because of such an estimate of quantities, or because of the character, location or other conditions pertaining to the Work. Payment shall be based on the actual quantities of work properly performed in accordance with the Contract, at the Contract unit prices specified. The Village reserves the right to increase, decrease or omit entirely, any or all items. No allowance will be made for any change in anticipated profits due to an increase or decrease in the original estimate of quantities.
- 2.7 The Bidder must submit his Bid on the form furnished by the Village. The Bid shall be executed properly, and Bids shall be made for all items indicated in the Bid Form. The Bidder shall indicate, in figures, a unit price or lump sum price for each of the separate items called for in the Bid Form. The Bidder shall show the products of the respective quantities and unit prices in the column provided for that purpose. The gross sum shown in the place indicated in the Bid Form shall be the summation of said products. All writing shall be with ink or typewriter, except the signature of the Bidder, which shall be written with ink.
- 2.8 In case of error in the extension of prices in the Bid, the hourly rate or unit price will govern. In case of discrepancy in the price between the written and numerical amounts, the written amount will govern.
- 2.9 All costs incurred in the preparation, submission, and/or presentation of any Bid including the Bidder's travel or personal expenses shall be the sole responsibility of the Bidder and will not be reimbursed by the Village.
- 2.10 The Bidder hereby affirms and states that the prices quoted herein constitute the total cost to the Village for all work involved in the respective items, as well as the materials to be furnished in accordance with the collective requirements of the Contract Documents. The Bidder also affirms that this cost includes all insurance, bonds, royalties, transportation charges, use of all tools and equipment, superintendence, overhead expense, profits and other work, services and conditions necessarily involved in the work to be done.
- 2.11 The Bidder shall complete and submit with the Bid an "Affidavit" (IDOT Form BC-57, or similar) listing all uncompleted contracts, including subcontract work; all pending low bids not yet awarded or rejected, and equipment available.
- 2.12 The Bidder shall complete and submit with the Bid a "Municipal Reference List" indicating other municipalities for which the Bidder has successfully performed similar work.
- 3. PRE-BID CONFERENCE**
- 3.1 A pre-bid conference may be offered to provide additional information, inspection or review of current facilities or equipment, and to provide an open forum for questions from Bidders. This pre-bid conference is not mandatory (unless stated "Required" on the cover of this document), but attendance by Bidders is strongly advised as this will be the last opportunity to ask questions concerning the Bid.

Village of Downers Grove

3.2 Questions may be posed in writing to the Village (faxed and emailed questions are acceptable), but must be received by the Village prior to the scheduled time for the pre-bid conference. Questions received will be considered at the conference. An addendum may be issued as a result of the pre-bid conference. Such an addendum is subject to the provisions for issuance of an addendum as set forth in Section 2.5 above.

3.3 No Contract Documents will be issued after the pre-bid conference except to attendees.

4. BID SUBMISSION

4.1 An original copy of the sealed bid marked as indicated in Section 1 shall be submitted to the Village.

4.2 A bid deposit will be required, which shall not exceed five percent (5%) of the estimated cost of the work to be furnished. Such bid deposit shall be in the form of a bid bond, certified check, cash or money order. Checks shall be drawn upon a bank of good standing payable to the order of the Village and said deposit shall be forfeited to the Village in the event the Bidder neglects or refuses to enter into a contract and bond when required, with approved sureties, to execute the Work or furnish the material for the price mentioned in his Bid and according to the plans and specifications in case the contract shall be awarded to him.

4.3 Bids shall be publicly opened at the hour and place indicated above.

5. BID MODIFICATION OR WITHDRAWAL

5.1 A Bid that is in the possession of the Village may be altered by a letter bearing the signature or name of the person authorized for submitting a Bid, provided that it is received prior to the time and date set for the bid opening. Telephone, email or verbal alterations of a Bid will not be accepted.

5.2 A Bid that is in the possession of the Village may be withdrawn by the Bidder, up to the time set for the bid opening, by a letter bearing the signature or name of the person authorized for submitting Bids. Bids may not be withdrawn after the bid opening and shall remain valid for a period of ninety (90) days from the date set for the bid opening, unless otherwise specified.

5.3 Any Bidder who does not submit a Bid is requested to return the enclosed Statement of "No Bid" postcard. Bidders not submitting Bids or "No Bid Statement" may otherwise be removed from the Village's bid mailing list.

6. BID REJECTION

6.1 Bids that contain omissions, erasures, alterations, additions not called for, conditional bids or alternate bids not called for, or irregularities of any kind, shall be rejected as informal or insufficient. Bids otherwise acceptable, which are not accompanied by the proper Proposal Guaranty, shall also be rejected as informal or insufficient. The Village reserves the right however, to reject any or all Bids and to waive such technical error as may be deemed best for the interest of the Village.

7. BIDDER COMPETENCY

7.1 No Bid will be accepted from or contract awarded to any person, firm or corporation that is in arrears or is in default upon any debt or contract. The Bidder, if requested, must present evidence to the Village of ability and possession of necessary facilities, and financial resources to comply with the terms of the Contract Documents. Evidence must be presented within three (3) business days.

Village of Downers Grove

8. BIDDER DISQUALIFICATION

8.1 Any one or more of the following causes may be considered as sufficient for the disqualification of a Bidder and the rejection of their Bid.

8.1.1 More than one Bid for the same Work from an individual, firm partnership, or corporation under the same or different names.

8.1.2 Evidence of collusion among Bidders.

8.1.3 Unbalanced Bids in which the prices for some items are substantially out of proportion to the prices for other items.

8.1.4 Failure to submit a unit price for each item of Work listed in the Bid Form.

8.1.5 Lack of competency as revealed by financial statement or experience questionnaire.

8.1.6 Unsatisfactory performance record as shown by past work, judged from the standpoint of workmanship and progress.

8.1.7 Uncompleted work which, in the judgment of the Village, might hinder or prevent the prompt completion of this Work.

8.1.8 Failure to submit a signed Bidder's Certificate stating the following:

8.1.8.1 That the Bidder is not barred from bidding on this Contract as a result of a violation of Sections 720 ILCS 5/33-E3 and 720 ILCS 5/33-E4 of the Illinois Compiled Statutes; and

8.1.8.2 The Bidder is not delinquent in the payment of any tax administered by the Illinois Department of Revenue; and

8.1.8.3 The Bidder will maintain the types and levels of insurance required by the terms of this contract; and

8.1.8.4 The Bidder will comply with the Illinois Prevailing Wage Act, 820 ILCS 130/1 *et seq.*

9. BASIS OF AWARD

9.1 The Village reserves the exclusive right to accept or reject any and all Bids or to waive sections, technicalities and irregularities, or to accept or reject any Bid or any item of any Bid.

10. AWARD OF CONTRACT

10.1 Unless the Village exercises its right to reject all Bids, the Contract will be awarded to that responsible Bidder whose Bid, conforming to the Contract Documents, will be most advantageous to the Village, price and other factors considered. (the credentials, financial information, bonding capacity, insurance protection, qualifications of the labor and management of the firm, past experience and ability to complete the project within time frame required - lowest responsible bidder)

Village of Downers Grove

10.2 Unless otherwise specified, if a Contract is not awarded within ninety (90) days after the opening of Bids, a Bidder may file a written request with the Village for the withdrawal of their Bid. The Village will have a maximum of ten (10) days after the receipt of such request to award the Contract or release the Bidder from further obligation by return of the Bidder's bid deposit. Any attempt or actual withdrawal or cancellation of a Bid by the awarded contractor who has been notified by the Village of the acceptance of said Bid shall be considered a breach of contract.

11. RETURN OF BID DEPOSIT

11.1 The bid deposit of all except the three (3) lowest responsive bidders on each contract will be returned within fifteen (15) days after the opening of Bids. The remaining bid deposits of each contractor will be returned within fifteen (15) days after the Village Council has awarded the contract and the required appurtenances to the contract have been received.

12. FAILURE TO ENTER INTO CONTRACT

12.1 Failure on the part of the successful Bidder to execute a Contract and provide acceptable bonds, as provided herein, within ten (10) days from the date of receipt of the Contract and Notice of Award from the Village, will be considered as just cause for the revocation of the award. The Bidder's bid security shall then be forfeited to the Village, not as a penalty but in payment of liquidated damages sustained as a result of such failure.

12.2 The Bidder shall not be allowed to claim lack of receipt where the Contract and Notice of Award was mailed by U.S. Postal Services certified mail to the business address listed in his Bid. In case the Village does not receive evidence of receipt within ten (10) days of the date of Notice of Award, the Village may revoke the award. The Bidder shall then forfeit the bid security to the Village, not as a penalty but in payment of liquidated damages sustained as the result of such failure to execute the Contract.

12.3 By submitting a Bid, the Bidder understands and agrees that, if his Bid is accepted, and he fails to enter into a contract forthwith, he shall be liable to the Village for any damages the Village may thereby suffer.

13. SECURITY FOR PERFORMANCE

13.1 The successful Bidder shall, within ten (10) days after acceptance of the Bidder's Bid by the Village, furnish a Performance Bond and a Materials and Labor Payment Bond acceptable to the Village in the full amount of the Bid. Said bonds shall guarantee the Bidder's performance under the Contract Documents and shall guarantee payment of all subcontractors and material suppliers. Any bond shall include a provision as will guarantee faithful performance of the Illinois Prevailing Wage Act, 820 ILCS 130/1 et seq.

14. TAX EXEMPTION

14.1 The Village is exempt from Illinois sales or use tax for direct purchases of materials and supplies. A copy of the Illinois Sales Tax Exemption Form will be issued upon request. The Village's federal identification number will also be provided to the selected Bidder.

Village of Downers Grove

15. RESERVED RIGHTS

- 15.1 The Village reserves the right to waive sections, irregularities, technicalities and informalities to this Contract and to accept any Bid and to reject any and all Bids and to disapprove of any and all subcontractors as may be in the best interest of the Village. Time and date requirements for receipt of Bids, however, will not be waived.

16. CATALOGS AND SHOP DRAWINGS

- 16.1 Each Bidder shall submit catalogs, descriptive literature, and detailed drawings, where applicable, to fully illustrate and describe the work or material he proposes to furnish.

17. TRADE NAMES AND SUBSTITUTIONS

- 17.1 Certain materials and equipment are specified by a manufacturer or trade name to establish standards or quality and performance and not for the purpose of limiting competition. Products of other manufacturers may be substituted, if, in the opinion of the Village, they are equal to those specified in quality, performance, design, and suitability for intended use. If the Bidder proposes to furnish an "equal", the proposed "equal" item must be so indicated in the written Bid. Where two or more items are specified, the selection among those specified is the Bidder's option, or he may submit his Bid on all such items. Detail specification sheets shall be provided by Bidder for all substituted items.

II. TERMS AND CONDITIONS

18. VILLAGE ORDINANCES

18.1 The successful Bidder, now the Contractor, will strictly comply with all ordinances of the Village of Downers Grove and laws of the State of Illinois.

19. USE OF VILLAGE'S NAME

19.1 The Contractor is specifically denied the right of using in any form or medium the name of the Village for public advertising unless the Village grants express permission.

20. HOURS OF WORK

20.1 The Contractor shall do no work between the hours of 7:00 p.m. and 7:00 a.m., nor on Saturdays, Sundays or legal holidays, unless otherwise approved in writing by the Village. However, such work may be performed at any time if necessary, for the proper care and protection of work already performed, or in case of an emergency. All after-hour work is still subject to the permission of the Village.

21. PERMITS AND LICENSES

21.1 The Contractor shall obtain all necessary permits and licenses required to complete the Work. The cost of acquisition of all necessary permits, bonds, insurance and services as specified herein shall be considered INCIDENTAL, and no additional compensation will be allowed the Contractor.

22. INSPECTION

22.1 The Village shall have a right to inspect, by its authorized representative, any material, components or workmanship as herein specified. Materials, components or workmanship that have been rejected by the Village as not in accordance with the terms of the contract specifications shall be replaced by the Contractor at no cost to the Village.

23. DELIVERIES

23.1 All materials shipped to the Village must be shipped F.O.B. designated location, Downers Grove, Illinois.

24. SPECIAL HANDLING

24.1 Prior to delivery of any product that is caustic, corrosive, flammable or dangerous to handle, the Contractor will provide written directions as to methods of handling such products, as well as the antidote or neutralizing material required for its first aid before delivery. Contractor shall also notify the Village and provide material safety data sheets for all substances used in connection with this Contract which are defined as toxic under the Illinois Toxic Substances Disclosure to Employees Act.

25. NONDISCRIMINATION

25.1 Contractor shall, as a party to a public contract:

25.1.1 Refrain from unlawful discrimination in employment and undertake affirmative action to assure equality of employment opportunity and eliminate the effects of past discrimination;

25.1.2 By submission of this Bid, the Contractor certifies that he is an "equal opportunity employer" as defined by Section 2000(e) of Chapter 21, Title 42, U.S. Code Annotated and Executive Orders #11246 and #11375, which are incorporated herein by reference. The Equal Opportunity clause, Section 6.1 of the Rules and Regulations of the Department of Human Rights of the State of Illinois, is a material part of any contract awarded on the basis of this Bid.

25.2 It is unlawful to discriminate on the basis of race, color, sex, national origin, ancestry, age, marital status, physical or mental handicap or unfavorable discharge for military service. Contractor shall comply with standards set forth in Title VII of the Civil Rights Act of 1964, 42 U.S.C. Secs. 2000 et seq., The Human Rights Act of the State of Illinois, 775 ILCS 5/1-101 et. seq, and The Americans With Disabilities Act, 42 U.S.C. Secs. 12101 et. seq.

26. SEXUAL HARASSMENT POLICY

26.1 The Contractor, as a party to a public contract, shall have a written sexual harassment policy that:

26.1.1 Notes the illegality of sexual harassment;

26.1.2 Sets forth the State law definition of sexual harassment;

26.1.3 Describes sexual harassment utilizing examples;

26.1.4 Describes the Contractor's internal complaint process including penalties;

26.1.5 Describes the legal recourse, investigative and complaint process available through the Illinois Department of Human Rights and the Human Rights Commission and how to contact these entities; and

26.1.6 Describes the protection against retaliation afforded under the Illinois Human Rights Act.

27. EQUAL EMPLOYMENT OPPORTUNITY

27.1 In the event of the Contractor's non-compliance with the provisions of this Equal Employment Opportunity Clause, the Illinois Human Rights Act or the Rules and Regulations of the Illinois Department of Human Rights ("Department"), the Contractor may be declared ineligible for future contracts or subcontracts with the State of Illinois or any of its political subdivisions or municipal corporations, and the contract may be canceled or voided in whole or in part, and such other sanctions or penalties may be imposed or remedies invoked as provided by statute or regulation. During the performance of this Contract, the Contractor agrees as follows:

27.1.1 That it will not discriminate against any employee or applicant for employment because of race, color, religion, sex, marital status, national origin or ancestry, age, physical or mental disability unrelated to ability, military status, order of protection status, sexual orientation, sexual identity, or an unfavorable discharge from military service; and further that it will examine all job classifications to determine if minority persons or women are underutilized and will take appropriate affirmative action to rectify any such underutilization.

Village of Downers Grove

- 27.1.2 That, if it hires additional employees in order to perform this Contract or any portion thereof, it will determine the availability (in accordance with the Department's Rules and Regulations) of minorities and women in the area(s) from which it may reasonably recruit and it will hire for each job classification for which employees are hired in such a way that minorities and women are not underutilized.
- 27.1.3 That, in all solicitations or advertisements for employees placed by it or on its behalf, it will state that all applicants will be afforded equal opportunity without discrimination because of race, color, religion, sex, marital status, national origin or ancestry, age, physical or mental disability unrelated to ability, military status, order of protection status, sexual orientation, or an unfavorable discharge from military services.
- 27.1.4 That it will send to each labor organization or representative of workers with which it has or is bound by a collective bargaining or other agreement or understanding, a notice advising such labor organization or representative of the Contractor's obligations under the Illinois Human Rights Act and the Department's Rules and Regulations. If any such labor organization or representative fails or refuses to cooperate with the Contractor in its efforts to comply with such Act and Rules and Regulations, the Contractor will promptly so notify the Department and the contracting agency and will recruit employees from other sources when necessary to fulfill its obligations thereunder.
- 27.1.5 That it will submit reports as required by the Department's Rules and Regulations, furnish all relevant information as may from time to time be requested by the Department or the contracting agency, and in all respects comply with the Illinois Human Rights Act and the Department's Rules and Regulations.
- 27.1.6 That it will permit access to all relevant books, records, accounts and work sites by personnel of the contracting agency and the Department for purpose of investigation to ascertain compliance with the Illinois Human Rights Act and the Department's Rules and Regulations.
- 27.1.7 That it will include verbatim or by reference the provisions of this clause in every subcontract it awards under which any portion of the contract obligations are undertaken or assumed, so that such provisions will be binding upon such subcontractor. In the same manner as with other provisions of this Contract, the Contractor will be liable for compliance with applicable provisions of this clause by such subcontractors; and further it will promptly notify the contracting agency and the Department in the event any subcontractor fails or refuses to comply therewith. In addition, the Contractor will not utilize any subcontractor declared by the Illinois Human Rights Commission to be ineligible for contracts or subcontracts with the State of Illinois or any of its political subdivision or municipal corporations.

28. DRUG FREE WORK PLACE

- 28.1 Contractor, as a party to a public contract, certifies and agrees that it will provide a drug free workplace by:

Village of Downers Grove

- 28.1.1 Publishing a statement:
- (1) Notifying employees that the unlawful manufacture, distribution, dispensation, possession or use of a controlled substance, including cannabis, is prohibited in the Village's or Contractor's workplace.
 - (2) Specifying the actions that will be taken against employees for violations of such prohibition.
 - (3) Notifying the employee that, as a condition of employment on such contract or grant, the employee will:
 - (A) abide by the terms of the statement; and
 - (B) notify the employer of any criminal drug statute conviction for a violation occurring in the workplace no later than five (5) days after such conviction.
- 28.1.2 Establishing a drug free awareness program to inform employees about:
- (1) the dangers of drug abuse in the workplace;
 - (2) the Village's or Contractor's policy of maintaining a drug free workplace;
 - (3) any available drug counseling, rehabilitation and employee assistance programs;
 - (4) the penalties that may be imposed upon employees for drug violations.
- 28.1.3 Providing a copy of the statement required by subparagraph 1.1 to each employee engaged in the performance of the contract or grant and to post the statement in a prominent place in the workplace.
- 28.1.4 Notifying the contracting or granting agency within ten (10) days after receiving notice under part (3)(B) of subparagraph 1.1 above from an employee or otherwise receiving actual notice of such conviction.
- 28.1.5 Imposing a sanction on, or requiring the satisfactory participation in a drug abuse assistance or rehabilitation program by, any employee who is so convicted as required by section 5 of the Drug Free Workplace Act.
- 28.1.6 Assisting employees in selecting a course of action in the event drug counseling, treatment and rehabilitation is required and indicating that a trained referral team is in place.
- 28.1.7 Making a good faith effort to continue to maintain a drug free workplace through implementation of the Drug Free Workplace Act.
- 29. SUBSTANCE ABUSE PREVENTION ON PUBLIC WORKS PROJECTS ACT**
- 29.1 In the event this is a public works project as defined under the Prevailing Wage Act, 820 ILCS 130/2, Contractor agrees to comply with the Substance Abuse Prevention on Public Works Projects Act, 820 ILCS 265/1 *et seq.*, and further agrees that all of its subcontractors shall comply with such Act. As required by the Act, Contractor agrees that it will file with the Village prior to commencing work its written substance abuse prevention program and/or that of its subcontractor(s) which meet or exceed the requirements of the Act.

Village of Downers Grove

30. PREVAILING WAGE ACT

- 30.1 Contractor agrees to comply with the Illinois Prevailing Wage Act, 820 ILCS 130/1 *et seq.*, for all work completed under this Contract. Contractor agrees to pay the prevailing wage and require that all of its subcontractors pay prevailing wage to any laborers, workers or mechanics who perform work pursuant to this Contract or related subcontract. For applicable rates, go to the State of Illinois – Department of Labor website (www.state.il.us/agency/idol/rates/rates.HTM) and use the most current DuPage County rate. The Department revises the prevailing wage rates and the Contractor or subcontractor has an obligation to check the Department's website for revisions to prevailing wage rates throughout the duration of this Contract.
- 30.2 Contractor and each subcontractor shall keep or cause to be kept accurate records of all laborers, mechanics and other workers employed by them on the public works project, which records must include each worker's name, address, telephone number when available, social security number, classification, hourly wage paid (including itemized hourly cash and fringe benefits paid in each pay period), number of hours worked each day, and the starting and ending times of work each day. These records shall be open to inspection at all reasonable hours by any representative of the Village or the Illinois Department of Labor and must be preserved for three (3) years from the date of the last payment on the public work.
- 30.3 Since this is a contract for a public works project, as defined in 820 ILCS 130/2, Contractor agrees to post at the job site in an easily accessible place, the prevailing wages for each craft or type of worker or mechanic needed to execute the contract or work to be performed.
- 30.4 Because this is a public works project as defined under the Prevailing Wage Act, 820 ILCS 130/2, any and all contractors and subcontractors shall submit certified payroll records to the Village no later than the tenth (10th) day of each calendar month for the immediately preceding month in which construction on a public works project has occurred. **WITHOUT THIS PAPERWORK, NO INVOICE SHALL BE PAID BY THE VILLAGE.** Contractors and subcontractors must also submit a statement affirming that the records are true and accurate, that the wages paid to each worker are not less than the prevailing rate, and that the contractor and subcontractor are aware that filing false records is a Class A misdemeanor. The records must include the name, address, telephone number, social security number, job classification, hours of work, hourly rate, and start and end time of work each day for every worker

PCL XL error

Subsystem: KERNEL

Error: MissingData

Operator: VendorUnique

Position: 723

CALL FOR BIDS – FIXED WORKS PROJECT

Bid No.: S-006-13

The VILLAGE OF DOWNERS GROVE will receive bids Monday thru Friday, 8:00 A.M. to 5:00 P.M. at the Public Works Building, 5101 Walnut Avenue, Downers Grove, IL 60515.

The Village Council reserves the right to accept or reject any and all bids, to waive technicalities and to accept or reject any item of any Bid.

The documents constituting component parts of this Contract are the following:

- I. CALL FOR BIDS
- II. TERMS & CONDITIONS
- III. GENERAL PROVISIONS
- IV. SPECIAL PROVISIONS
- V. BID & CONTRACT FORM

All Bidders MUST submit the entire bid package, with one original Bid Form. Upon formal Award, the successful Bid will automatically convert to a Contract, and the successful Bidder will receive a copy of the executed contract upon formal award of the Bid with the Notice of Award.

DO NOT DETACH ANY PORTION OF THIS DOCUMENT. INVALIDATION COULD RESULT.

I. CALL FOR BIDS and INSTRUCTIONS TO BIDDERS

1. GENERAL

- 1.1 Notice is hereby given that Village of Downers Grove will receive sealed bids up to:
WEDNESDAY, APRIL 17, 2013 @ 1:00 PM
 - 1.2 Defined Terms:
 - 1.2.1 Village – the Village of Downers Grove acting through its officers or agents.
 - 1.2.2 Contract Documents – this document plus any drawings issued therewith, any addenda and the Bidder's completed proposal, bonds and all required certifications.
 - 1.2.3 Bid – this document completed by an individual or entity and submitted to the Village.
 - 1.2.4 Bidder – the individual or entity who submits or intends to submit a bid proposal to the Village.
 - 1.2.5 Contractor – the individual or entity whose bid is selected by the Village and who enters into a contract with the Village.
 - 1.2.6 Work – the construction or service defined herein.
 - 1.2.7 Day – unless otherwise stated all references to day “Day” “Days”, “day” or “days” shall refer to calendar days.
 - 1.2.8 Proposal Guaranty – the required bid deposit.
 - 1.3 Bids must be received at the Village by the time and date specified. Bids received after the specified time and date will not be accepted and will be returned unopened to the Bidder.
 - 1.4 Bids shall be sent to the Village of Downers Grove, in a sealed envelope marked "SEALED BID". The envelope shall be marked with the name of the project, date, and time set for receipt of Bids. The bid package may be submitted any time prior to the time set for receipt of Bids.
 - 1.5 All Bids must be submitted on the forms supplied by the Village and signed by a proper official of the company submitting the Bid. Telephone, email and fax Bids will not be accepted.
 - 1.6 Under penalty of perjury, the Bidder certifies by submitting this Bid that he has not acted in collusion with any other Bidder or potential Bidder.
- ### **2. BID PREPARATION**
- 2.1 It is the responsibility of the Bidder to carefully examine the Contract Documents and to be familiar with all of the requirements, stipulations, provisions, and conditions surrounding the proposed Work.

- 2.2 The Bidder shall inspect the site of the proposed Work in detail, investigate and become familiar with all the local conditions affecting the Work and become fully acquainted with the detailed requirements of the Work. Submitting a Bid shall be a conclusive assurance and warranty that the Bidder has made these examinations and that the Bidder understands all requirements for the performance of the Work. If the Bid is accepted, the Bidder will be responsible for all errors in the Bid resulting from his willing or neglectful failure to comply with these instructions. IN NO CASE WILL THE VILLAGE BE RESPONSIBLE FOR ANY COSTS, EXPENSES, LOSSES OR CHANGES IN ANTICIPATED MARGINS OF PROFIT RESULTING FROM THE WILLING OR NEGLECTFUL FAILURE OF THE BIDDER TO MAKE THESE EXAMINATIONS. THE VILLAGE WILL NOT BE RESPONSIBLE FOR ANY COSTS, EXPENSES, LOSSES OR CHANGES IN ANTICIPATED MARGINS OF PROFIT RESULTING FROM THE WILLING OR NEGLECTFUL FAILURE OF THE CONTRACTOR TO PROVIDE THE KNOWLEDGE, EXPERIENCE AND ABILITY TO PERFORM THE WORK REQUIRED BY THIS CONTRACT. No changes in the prices, quantities or contract provisions shall be made to accommodate the inadequacies of the Bidder, which might be discovered subsequent to award of contract. The Bidder shall take no advantage of any error or omission in the Contract Documents nor shall any error or omission in the Contract Documents serve as the basis for an adjustment of the amounts paid to the Bidder.
- 2.3 When the Contract Documents include information pertaining to subsurface explorations, borings, test pits, and other preliminary investigations, such information is included solely for the convenience of the Bidder. *The Village assumes no responsibility whatsoever with respect to the sufficiency of the information, and does not warrant, neither expressly nor by implication, that the conditions indicated represent those existing throughout the Work, or that unanticipated developments may not occur.*
- 2.4 Any information shown in the Contract Documents regarding the locations of underground utility facilities is included solely for the convenience of the Bidder. The Village assumes no responsibility whatsoever with respect to the sufficiency, accuracy or inadequacy of such information. It shall be the Bidder's responsibility to obtain detailed information from the respective utility companies relating to the location of their facilities and the work schedules of the utility companies for removing or adjusting them. Utilities whose facilities may be affected by the work include, but may not be limited to, the following: Nicor, ComEd, SBC, Comcast Cable, Downers Grove Sanitary District, and Village water, storm sewer, and street lighting systems.
- 2.5 No oral or telephone interpretations of specifications shall be binding upon the Village. All requests for interpretations or clarifications shall be made in writing and received by the Village at least five (5) business days prior to the date set for receipt of Bids or the pre-bid conference, if offered. The Village shall make all changes or interpretations of the Contract Documents in a written addendum and shall provide an addendum to any Bidder of record. Any and all changes to the Contract Documents are valid only if they are included by written addendum to all Bidders. Each Bidder must acknowledge receipt of any addenda by indicating same on the Bid Form. Each Bidder, by acknowledging receipt of any addenda, is responsible for the contents of the addenda and any changes to the Bid therein. Failure to acknowledge any addenda may cause the Bid to be rejected. The Village will not assume responsibility for receipt of any addenda. In all cases, it will be the Bidder's responsibility to obtain all addenda issued. Bidders will provide written acknowledgement of receipt of each addendum issued with the bid submission.

Village of Downers Grove

- 2.6 An estimate of the quantities of Work to be performed and the materials to be furnished is shown in the Bid Form. It is given as a basis for comparing the properly submitted Bids, and shall be used by the Village in awarding the Contract. The Village does not expressly warrant nor imply that the estimated quantities shown will correspond with those quantities required to perform the Work. No Bidder shall plead misunderstanding or deception because of such an estimate of quantities, or because of the character, location or other conditions pertaining to the Work. Payment shall be based on the actual quantities of work properly performed in accordance with the Contract, at the Contract unit prices specified. The Village reserves the right to increase, decrease or omit entirely, any or all items. No allowance will be made for any change in anticipated profits due to an increase or decrease in the original estimate of quantities.
- 2.7 The Bidder must submit his Bid on the form furnished by the Village. The Bid shall be executed properly, and Bids shall be made for all items indicated in the Bid Form. The Bidder shall indicate, in figures, a unit price or lump sum price for each of the separate items called for in the Bid Form. The Bidder shall show the products of the respective quantities and unit prices in the column provided for that purpose. The gross sum shown in the place indicated in the Bid Form shall be the summation of said products. All writing shall be with ink or typewriter, except the signature of the Bidder, which shall be written with ink.
- 2.8 In case of error in the extension of prices in the Bid, the hourly rate or unit price will govern. In case of discrepancy in the price between the written and numerical amounts, the written amount will govern.
- 2.9 All costs incurred in the preparation, submission, and/or presentation of any Bid including the Bidder's travel or personal expenses shall be the sole responsibility of the Bidder and will not be reimbursed by the Village.
- 2.10 The Bidder hereby affirms and states that the prices quoted herein constitute the total cost to the Village for all work involved in the respective items, as well as the materials to be furnished in accordance with the collective requirements of the Contract Documents. The Bidder also affirms that this cost includes all insurance, bonds, royalties, transportation charges, use of all tools and equipment, superintendence, overhead expense, profits and other work, services and conditions necessarily involved in the work to be done.
- 2.11 The Bidder shall complete and submit with the Bid an "Affidavit" (IDOT Form BC-57, or similar) listing all uncompleted contracts, including subcontract work; all pending low bids not yet awarded or rejected, and equipment available.
- 2.12 The Bidder shall complete and submit with the Bid a "Municipal Reference List" indicating other municipalities for which the Bidder has successfully performed similar work.
- 3. PRE-BID CONFERENCE**
- 3.1 A pre-bid conference may be offered to provide additional information, inspection or review of current facilities or equipment, and to provide an open forum for questions from Bidders. This pre-bid conference is not mandatory (unless stated "Required" on the cover of this document), but attendance by Bidders is strongly advised as this will be the last opportunity to ask questions concerning the Bid.

Village of Downers Grove

3.2 Questions may be posed in writing to the Village (faxed and emailed questions are acceptable), but must be received by the Village prior to the scheduled time for the pre-bid conference. Questions received will be considered at the conference. An addendum may be issued as a result of the pre-bid conference. Such an addendum is subject to the provisions for issuance of an addendum as set forth in Section 2.5 above.

3.3 No Contract Documents will be issued after the pre-bid conference except to attendees.

4. BID SUBMISSION

4.1 An original copy of the sealed bid marked as indicated in Section 1 shall be submitted to the Village.

4.2 A bid deposit will be required, which shall not exceed five percent (5%) of the estimated cost of the work to be furnished. Such bid deposit shall be in the form of a bid bond, certified check, cash or money order. Checks shall be drawn upon a bank of good standing payable to the order of the Village and said deposit shall be forfeited to the Village in the event the Bidder neglects or refuses to enter into a contract and bond when required, with approved sureties, to execute the Work or furnish the material for the price mentioned in his Bid and according to the plans and specifications in case the contract shall be awarded to him.

4.3 Bids shall be publicly opened at the hour and place indicated above.

5. BID MODIFICATION OR WITHDRAWAL

5.1 A Bid that is in the possession of the Village may be altered by a letter bearing the signature or name of the person authorized for submitting a Bid, provided that it is received prior to the time and date set for the bid opening. Telephone, email or verbal alterations of a Bid will not be accepted.

5.2 A Bid that is in the possession of the Village may be withdrawn by the Bidder, up to the time set for the bid opening, by a letter bearing the signature or name of the person authorized for submitting Bids. Bids may not be withdrawn after the bid opening and shall remain valid for a period of ninety (90) days from the date set for the bid opening, unless otherwise specified.

5.3 Any Bidder who does not submit a Bid is requested to return the enclosed Statement of "No Bid" postcard. Bidders not submitting Bids or "No Bid Statement" may otherwise be removed from the Village's bid mailing list.

6. BID REJECTION

6.1 Bids that contain omissions, erasures, alterations, additions not called for, conditional bids or alternate bids not called for, or irregularities of any kind, shall be rejected as informal or insufficient. Bids otherwise acceptable, which are not accompanied by the proper Proposal Guaranty, shall also be rejected as informal or insufficient. The Village reserves the right however, to reject any or all Bids and to waive such technical error as may be deemed best for the interest of the Village.

7. BIDDER COMPETENCY

7.1 No Bid will be accepted from or contract awarded to any person, firm or corporation that is in arrears or is in default upon any debt or contract. The Bidder, if requested, must present evidence to the Village of ability and possession of necessary facilities, and financial resources to comply with the terms of the Contract Documents. Evidence must be presented within three (3) business days.

8. BIDDER DISQUALIFICATION

8.1 Any one or more of the following causes may be considered as sufficient for the disqualification of a Bidder and the rejection of their Bid.

8.1.1 More than one Bid for the same Work from an individual, firm partnership, or corporation under the same or different names.

8.1.2 Evidence of collusion among Bidders.

8.1.3 Unbalanced Bids in which the prices for some items are substantially out of proportion to the prices for other items.

8.1.4 Failure to submit a unit price for each item of Work listed in the Bid Form.

8.1.5 Lack of competency as revealed by financial statement or experience questionnaire.

8.1.6 Unsatisfactory performance record as shown by past work, judged from the standpoint of workmanship and progress.

8.1.7 Uncompleted work which, in the judgment of the Village, might hinder or prevent the prompt completion of this Work.

8.1.8 Failure to submit a signed Bidder's Certificate stating the following:

8.1.8.1 That the Bidder is not barred from bidding on this Contract as a result of a violation of Sections 720 ILCS 5/33-E3 and 720 ILCS 5/33-E4 of the Illinois Compiled Statutes; and

8.1.8.2 The Bidder is not delinquent in the payment of any tax administered by the Illinois Department of Revenue; and

8.1.8.3 The Bidder will maintain the types and levels of insurance required by the terms of this contract; and

8.1.8.4 The Bidder will comply with the Illinois Prevailing Wage Act, 820 ILCS 130/1 *et seq.*

9. BASIS OF AWARD

9.1 The Village reserves the exclusive right to accept or reject any and all Bids or to waive sections, technicalities and irregularities, or to accept or reject any Bid or any item of any Bid.

10. AWARD OF CONTRACT

10.1 Unless the Village exercises its right to reject all Bids, the Contract will be awarded to that responsible Bidder whose Bid, conforming to the Contract Documents, will be most advantageous to the Village, price and other factors considered. (the credentials, financial information, bonding capacity, insurance protection, qualifications of the labor and management of the firm, past experience and ability to complete the project within time frame required - lowest responsible bidder)

- 10.2 Unless otherwise specified, if a Contract is not awarded within ninety (90) days after the opening of Bids, a Bidder may file a written request with the Village for the withdrawal of their Bid. The Village will have a maximum of ten (10) days after the receipt of such request to award the Contract or release the Bidder from further obligation by return of the Bidder's bid deposit. Any attempt or actual withdrawal or cancellation of a Bid by the awarded contractor who has been notified by the Village of the acceptance of said Bid shall be considered a breach of contract.

11. RETURN OF BID DEPOSIT

- 11.1 The bid deposit of all except the three (3) lowest responsive bidders on each contract will be returned within fifteen (15) days after the opening of Bids. The remaining bid deposits of each contractor will be returned within fifteen (15) days after the Village Council has awarded the contract and the required appurtenances to the contract have been received.

12. FAILURE TO ENTER INTO CONTRACT

- 12.1 Failure on the part of the successful Bidder to execute a Contract and provide acceptable bonds, as provided herein, within ten (10) days from the date of receipt of the Contract and Notice of Award from the Village, will be considered as just cause for the revocation of the award. The Bidder's bid security shall then be forfeited to the Village, not as a penalty but in payment of liquidated damages sustained as a result of such failure.
- 12.2 The Bidder shall not be allowed to claim lack of receipt where the Contract and Notice of Award was mailed by U.S. Postal Services certified mail to the business address listed in his Bid. In case the Village does not receive evidence of receipt within ten (10) days of the date of Notice of Award, the Village may revoke the award. The Bidder shall then forfeit the bid security to the Village, not as a penalty but in payment of liquidated damages sustained as the result of such failure to execute the Contract.
- 12.3 By submitting a Bid, the Bidder understands and agrees that, if his Bid is accepted, and he fails to enter into a contract forthwith, he shall be liable to the Village for any damages the Village may thereby suffer.

13. SECURITY FOR PERFORMANCE

- 13.1 The successful Bidder shall, within ten (10) days after acceptance of the Bidder's Bid by the Village, furnish a Performance Bond and a Materials and Labor Payment Bond acceptable to the Village in the full amount of the Bid. Said bonds shall guarantee the Bidder's performance under the Contract Documents and shall guarantee payment of all subcontractors and material suppliers. Any bond shall include a provision as will guarantee faithful performance of the Illinois Prevailing Wage Act, 820 ILCS 130/1 et seq.

14. TAX EXEMPTION

- 14.1 The Village is exempt from Illinois sales or use tax for direct purchases of materials and supplies. A copy of the Illinois Sales Tax Exemption Form will be issued upon request. The Village's federal identification number will also be provided to the selected Bidder.

Village of Downers Grove

15. RESERVED RIGHTS

- 15.1 The Village reserves the right to waive sections, irregularities, technicalities and informalities to this Contract and to accept any Bid and to reject any and all Bids and to disapprove of any and all subcontractors as may be in the best interest of the Village. Time and date requirements for receipt of Bids, however, will not be waived.

16. CATALOGS AND SHOP DRAWINGS

- 16.1 Each Bidder shall submit catalogs, descriptive literature, and detailed drawings, where applicable, to fully illustrate and describe the work or material he proposes to furnish.

17. TRADE NAMES AND SUBSTITUTIONS

- 17.1 Certain materials and equipment are specified by a manufacturer or trade name to establish standards or quality and performance and not for the purpose of limiting competition. Products of other manufacturers may be substituted, if, in the opinion of the Village, they are equal to those specified in quality, performance, design, and suitability for intended use. If the Bidder proposes to furnish an "equal", the proposed "equal" item must be so indicated in the written Bid. Where two or more items are specified, the selection among those specified is the Bidder's option, or he may submit his Bid on all such items. Detail specification sheets shall be provided by Bidder for all substituted items.

II. TERMS AND CONDITIONS

18. VILLAGE ORDINANCES

- 18.1 The successful Bidder, now the Contractor, will strictly comply with all ordinances of the Village of Downers Grove and laws of the State of Illinois.

19. USE OF VILLAGE'S NAME

- 19.1 The Contractor is specifically denied the right of using in any form or medium the name of the Village for public advertising unless the Village grants express permission.

20. HOURS OF WORK

- 20.1 The Contractor shall do no work between the hours of 7:00 p.m. and 7:00 a.m., nor on Saturdays, Sundays or legal holidays, unless otherwise approved in writing by the Village. However, such work may be performed at any time if necessary, for the proper care and protection of work already performed, or in case of an emergency. All after-hour work is still subject to the permission of the Village.

21. PERMITS AND LICENSES

- 21.1 The Contractor shall obtain all necessary permits and licenses required to complete the Work. The cost of acquisition of all necessary permits, bonds, insurance and services as specified herein shall be considered INCIDENTAL, and no additional compensation will be allowed the Contractor.

22. INSPECTION

- 22.1 The Village shall have a right to inspect, by its authorized representative, any material, components or workmanship as herein specified. Materials, components or workmanship that have been rejected by the Village as not in accordance with the terms of the contract specifications shall be replaced by the Contractor at no cost to the Village.

23. DELIVERIES

- 23.1 All materials shipped to the Village must be shipped F.O.B. designated location, Downers Grove, Illinois.

24. SPECIAL HANDLING

- 24.1 Prior to delivery of any product that is caustic, corrosive, flammable or dangerous to handle, the Contractor will provide written directions as to methods of handling such products, as well as the antidote or neutralizing material required for its first aid before delivery. Contractor shall also notify the Village and provide material safety data sheets for all substances used in connection with this Contract which are defined as toxic under the Illinois Toxic Substances Disclosure to Employees Act.

25. NONDISCRIMINATION

- 25.1 Contractor shall, as a party to a public contract:
- 25.1.1 Refrain from unlawful discrimination in employment and undertake affirmative action to assure equality of employment opportunity and eliminate the effects of past discrimination;

25.1.2 By submission of this Bid, the Contractor certifies that he is an "equal opportunity employer" as defined by Section 2000(e) of Chapter 21, Title 42, U.S. Code Annotated and Executive Orders #11246 and #11375, which are incorporated herein by reference. The Equal Opportunity clause, Section 6.1 of the Rules and Regulations of the Department of Human Rights of the State of Illinois, is a material part of any contract awarded on the basis of this Bid.

25.2 It is unlawful to discriminate on the basis of race, color, sex, national origin, ancestry, age, marital status, physical or mental handicap or unfavorable discharge for military service. Contractor shall comply with standards set forth in Title VII of the Civil Rights Act of 1964, 42 U.S.C. Secs. 2000 et seq., The Human Rights Act of the State of Illinois, 775 ILCS 5/1-101 et. seq, and The Americans With Disabilities Act, 42 U.S.C. Secs. 12101 et. seq.

26. SEXUAL HARASSMENT POLICY

26.1 The Contractor, as a party to a public contract, shall have a written sexual harassment policy that:

26.1.1 Notes the illegality of sexual harassment;

26.1.2 Sets forth the State law definition of sexual harassment;

26.1.3 Describes sexual harassment utilizing examples;

26.1.4 Describes the Contractor's internal complaint process including penalties;

26.1.5 Describes the legal recourse, investigative and complaint process available through the Illinois Department of Human Rights and the Human Rights Commission and how to contact these entities; and

26.1.6 Describes the protection against retaliation afforded under the Illinois Human Rights Act.

27. EQUAL EMPLOYMENT OPPORTUNITY

27.1 In the event of the Contractor's non-compliance with the provisions of this Equal Employment Opportunity Clause, the Illinois Human Rights Act or the Rules and Regulations of the Illinois Department of Human Rights ("Department"), the Contractor may be declared ineligible for future contracts or subcontracts with the State of Illinois or any of its political subdivisions or municipal corporations, and the contract may be canceled or voided in whole or in part, and such other sanctions or penalties may be imposed or remedies invoked as provided by statute or regulation. During the performance of this Contract, the Contractor agrees as follows:

27.1.1 That it will not discriminate against any employee or applicant for employment because of race, color, religion, sex, marital status, national origin or ancestry, age, physical or mental disability unrelated to ability, military status, order of protection status, sexual orientation, sexual identity, or an unfavorable discharge from military service; and further that it will examine all job classifications to determine if minority persons or women are underutilized and will take appropriate affirmative action to rectify any such underutilization.

- 27.1.2 That, if it hires additional employees in order to perform this Contract or any portion thereof, it will determine the availability (in accordance with the Department's Rules and Regulations) of minorities and women in the area(s) from which it may reasonably recruit and it will hire for each job classification for which employees are hired in such a way that minorities and women are not underutilized.
- 27.1.3 That, in all solicitations or advertisements for employees placed by it or on its behalf, it will state that all applicants will be afforded equal opportunity without discrimination because of race, color, religion, sex, marital status, national origin or ancestry, age, physical or mental disability unrelated to ability, military status, order of protection status, sexual orientation, or an unfavorable discharge from military services.
- 27.1.4 That it will send to each labor organization or representative of workers with which it has or is bound by a collective bargaining or other agreement or understanding, a notice advising such labor organization or representative of the Contractor's obligations under the Illinois Human Rights Act and the Department's Rules and Regulations. If any such labor organization or representative fails or refuses to cooperate with the Contractor in its efforts to comply with such Act and Rules and Regulations, the Contractor will promptly so notify the Department and the contracting agency and will recruit employees from other sources when necessary to fulfill its obligations thereunder.
- 27.1.5 That it will submit reports as required by the Department's Rules and Regulations, furnish all relevant information as may from time to time be requested by the Department or the contracting agency, and in all respects comply with the Illinois Human Rights Act and the Department's Rules and Regulations.
- 27.1.6 That it will permit access to all relevant books, records, accounts and work sites by personnel of the contracting agency and the Department for purpose of investigation to ascertain compliance with the Illinois Human Rights Act and the Department's Rules and Regulations.
- 27.1.7 That it will include verbatim or by reference the provisions of this clause in every subcontract it awards under which any portion of the contract obligations are undertaken or assumed, so that such provisions will be binding upon such subcontractor. In the same manner as with other provisions of this Contract, the Contractor will be liable for compliance with applicable provisions of this clause by such subcontractors; and further it will promptly notify the contracting agency and the Department in the event any subcontractor fails or refuses to comply therewith. In addition, the Contractor will not utilize any subcontractor declared by the Illinois Human Rights Commission to be ineligible for contracts or subcontracts with the State of Illinois or any of its political subdivision or municipal corporations.

28. DRUG FREE WORK PLACE

- 28.1 Contractor, as a party to a public contract, certifies and agrees that it will provide a drug free workplace by:

28.1.1 Publishing a statement:

(1) Notifying employees that the unlawful manufacture, distribution, dispensation, possession or use of a controlled substance, including cannabis, is prohibited in the Village's or Contractor's workplace.

(2) Specifying the actions that will be taken against employees for violations of such prohibition.

(3) Notifying the employee that, as a condition of employment on such contract or grant, the employee will:

(A) abide by the terms of the statement; and

(B) notify the employer of any criminal drug statute conviction for a violation occurring in the workplace no later than five (5) days after such conviction.

28.1.2 Establishing a drug free awareness program to inform employees about:

(1) the dangers of drug abuse in the workplace;

(2) the Village's or Contractor's policy of maintaining a drug free workplace;

(3) any available drug counseling, rehabilitation and employee assistance programs;

(4) the penalties that may be imposed upon employees for drug violations.

28.1.3 Providing a copy of the statement required by subparagraph 1.1 to each employee engaged in the performance of the contract or grant and to post the statement in a prominent place in the workplace.

28.1.4 Notifying the contracting or granting agency within ten (10) days after receiving notice under part (3)(B) of subparagraph 1.1 above from an employee or otherwise receiving actual notice of such conviction.

28.1.5 Imposing a sanction on, or requiring the satisfactory participation in a drug abuse assistance or rehabilitation program by, any employee who is so convicted as required by section 5 of the Drug Free Workplace Act.

28.1.6 Assisting employees in selecting a course of action in the event drug counseling, treatment and rehabilitation is required and indicating that a trained referral team is in place.

28.1.7 Making a good faith effort to continue to maintain a drug free workplace through implementation of the Drug Free Workplace Act.

29. SUBSTANCE ABUSE PREVENTION ON PUBLIC WORKS PROJECTS ACT

29.1 In the event this is a public works project as defined under the Prevailing Wage Act, 820 ILCS 130/2, Contractor agrees to comply with the Substance Abuse Prevention on Public Works Projects Act, 820 ILCS 265/1 *et seq.*, and further agrees that all of its subcontractors shall comply with such Act. As required by the Act, Contractor agrees that it will file with the Village prior to commencing work its written substance abuse prevention program and/or that of its subcontractor(s) which meet or exceed the requirements of the Act.

30. PREVAILING WAGE ACT

- 30.1 Contractor agrees to comply with the Illinois Prevailing Wage Act, 820 ILCS 130/1 *et seq.*, for all work completed under this Contract. Contractor agrees to pay the prevailing wage and require that all of its subcontractors pay prevailing wage to any laborers, workers or mechanics who perform work pursuant to this Contract or related subcontract. For applicable rates, go to the State of Illinois – Department of Labor website (www.state.il.us/agency/idol/rates/rates.HTM) and use the most current DuPage County rate. The Department revises the prevailing wage rates and the Contractor or subcontractor has an obligation to check the Department’s website for revisions to prevailing wage rates throughout the duration of this Contract.
- 30.2 Contractor and each subcontractor shall keep or cause to be kept accurate records of all laborers, mechanics and other workers employed by them on the public works project, which records must include each worker’s name, address, telephone number when available, social security number, classification, hourly wage paid (including itemized hourly cash and fringe benefits paid in each pay period), number of hours worked each day, and the starting and ending times of work each day. These records shall be open to inspection at all reasonable hours by any representative of the Village or the Illinois Department of Labor and must be preserved for three (3) years from the date of the last payment on the public work.
- 30.3 Since this is a contract for a public works project, as defined in 820 ILCS 130/2, Contractor agrees to post at the job site in an easily accessible place, the prevailing wages for each craft or type of worker or mechanic needed to execute the contract or work to be performed.
- 30.4 Because this is a public works project as defined under the Prevailing Wage Act, 820 ILCS 130/2, any and all contractors and subcontractors shall submit certified payroll records to the Village no later than the tenth (10th) day of each calendar month for the immediately preceding month in which construction on a public works project has occurred. **WITHOUT THIS PAPERWORK, NO INVOICE SHALL BE PAID BY THE VILLAGE.** Contractors and subcontractors must also submit a statement affirming that the records are true and accurate, that the wages paid to each worker are not less than the prevailing rate, and that the contractor and subcontractor are aware that filing false records is a Class A misdemeanor. The records must include the name, address, telephone number, social security number, job classification, hours of work, hourly rate, and start and end time of work each day for every worker employed on the public work. The Village reserves the right to check the pay stubs of the workers on the job. The Village further cautions that payment for any services rendered pursuant to this Contract may be predicated upon receipt of said records.
- 30.5 In the event that this is a construction project where Motor Fuel tax monies or state grant monies are used in the construction, maintenance and extension of municipal streets, traffic control signals, street lighting systems, storm sewers, pedestrian subways or overhead crossings, sidewalks and off-street parking facilities, and the like, the Village will require an Apprenticeship and Training Certification, attached after the Bidder’s Certification.
- 30.6 Any bond furnished as security for performance shall include a provision as will guarantee faithful performance of the Illinois Prevailing Wage Act, 820 ILCS 130/1 *et seq.*

31. PATRIOT ACT COMPLIANCE

31.1 The Contractor represents and warrants to the Village that neither it nor any of its principals, shareholders, members, partners, or affiliates, as applicable, is a person or entity named as a Specially Designated National and Blocked Person (as defined in Presidential Executive Order 13224) and that it is not acting, directly or indirectly, for or on behalf of a Specially Designated National and Blocked Person.

The Contractor further represents and warrants to the Village that the it and its principals, shareholders, members, partners, or affiliates, as applicable are not, directly or indirectly, engaged in, and are not facilitating, the transactions contemplated by this Contract on behalf of any person or entity named as a Specially Designated National and Blocked Person. The Contractor hereby agrees to defend, indemnify and hold harmless the Village, and its elected or appointed officers, employees, agents, representatives, engineers and attorneys, from and against any and all claims, damages, losses, risks, liabilities and expenses(including reasonable attorney's fees and costs) arising from or related to any breach of the foregoing representations and warranties.

32. INSURANCE REQUIREMENTS

32.1 Prior to starting the Work, Contractor and any Subcontractors shall procure, maintain and pay for such insurance as will protect against claims for bodily injury or death, or for damage to property, including loss of use, which may arise out of operations by the Contractor or Subcontractor or any Sub-Sub Contractor or by anyone employed by any of them, or by anyone for whose acts any of them may be liable. Such insurance shall not be less than the greater of coverages and limits of liability specified below or any coverages and limits of liability specified in the Contract Documents or coverages and limits required by law unless otherwise agreed to by the Village.

Workers Compensation	\$500,000	Statutory
Employers Liability	\$1,000,000	Each Accident
	\$1,000,000	Disease Policy Limit
	\$1,000,000	Disease Each Employee
Comprehensive General Liability	\$2,000,000	Each Occurrence
	\$2,000,000	Aggregate <i>(Applicable on a Per Project Basis)</i>
Commercial Automobile Liability	\$1,000,000	Each Accident
Professional Errors & Omissions (pursuant to section.9 below)	\$2,000,000	Each Claim
	\$2,000,000	Annual Aggregate
Umbrella Liability	\$ 5,000,000	

Village of Downers Grove

- 32.2 Comprehensive General Liability Insurance required under this paragraph shall be written on an occurrence form and shall include coverage for Products/Completed Operations, Personal Injury with Employment Exclusion (if any) deleted, Blanket XCU and Blanket Contractual Liability insurance applicable to defense and indemnity obligations and other contractual indemnity assumed under the Contract Documents. The limit must be on a "Per Project Basis".
- 32.3 Commercial Automobile Liability Insurance required under this paragraph shall include coverage for all owned, hired and non-owned automobiles.
- 32.4 Workers Compensation coverage shall include a waiver of subrogation against the Village.
- 32.5 Comprehensive General Liability, Employers Liability and Commercial Automobile Liability Insurance may be arranged under single policies for full minimum limits required, or by a combination of underlying policies with the balance provided by Umbrella and/or Excess Liability policies.
- 32.6 Contractor and all Subcontractors shall have their respective Comprehensive General Liability (including products/completed operations coverage), Employers Liability, Commercial Automobile Liability, and Umbrella/Excess Liability policies endorsed to add the "Village of Downers, its officers, officials, employees and volunteers" as "additional insureds" with respect to liability arising out of operations performed; claims for bodily injury or death brought against the Village by any Contractor or Subcontractor employees, or the employees of Subcontractor's subcontractors of any tier, however caused, related to the performance of operations under the Contract Documents. Such insurance afforded to the Village shall be endorsed to provide that the insurance provided under each policy shall be **Primary and Non-Contributory**.
- 32.7 Contractor and all Subcontractors shall maintain in effect all insurance coverages required by the Contract Documents at their sole expense and with insurance carriers licensed to do business in the State of Illinois and having a current A. M. Best rating of no less than A- VIII. In the event that the Contractor or any Subcontractor fails to procure or maintain any insurance required by the Contract Documents, the Village may, at its option, purchase such coverage and deduct the cost thereof from any monies due to the Contractor or Subcontractor, or withhold funds in an amount sufficient to protect the Village, or terminate this Contract pursuant to its terms.
- 32.8 All insurance policies shall contain a provision that coverages and limits afforded hereunder shall not be canceled, materially changed, non-renewed or restrictive modifications added, without thirty (30) days prior written notice to the Village. Renewal certificates shall be provided to the Village not less than five (5) days prior to the expiration date of any of the required policies. All Certificates of Insurance shall be in a form acceptable to the Village and shall provide satisfactory evidence of compliance with all insurance requirements. The Village shall not be obligated to review such certificates or other evidence of insurance, or to advise Contractor or Subcontractor of any deficiencies in such documents, and receipt thereof shall not relieve the Contractor or Subcontractor from, nor be deemed a waiver of the right to enforce the terms of the obligations hereunder. The Village shall have the right to examine any policy required and evidenced on the Certificate of Insurance.

Village of Downers Grove

- 32.9 If the Work under the Contract Documents includes design, consultation, or any other professional services, Contractor or the Subcontractor shall procure, maintain, and pay for Professional Errors and Omissions insurance with limits of not less than \$2,000,000 per claim and \$2,000,000 annual aggregate. If such insurance is written on a claim made basis, the retrospective date shall be prior to the start of the Work under the Contract Documents. Contractor and all Subcontractors agree to maintain such coverage for three (3) years after final acceptance of the Project by the Village or such longer period as the Contract Documents may require. Renewal policies during this period shall maintain the same retroactive date.
- 32.10 Any deductibles or self-insured retentions shall be the sole responsibility of the Insured. At the option of the Village, either: the insurer shall reduce or eliminate such deductibles or self-insured retentions as respects the Village, its officers, officials, employees and volunteers; or the Contractor shall procure a bond guaranteeing payment of losses and related investigations, claim administration and defense expenses.

33. INDEMNITY AND HOLD HARMLESS AGREEMENT

- 33.1 To the fullest extent permitted by law, the Contractor shall indemnify, keep and save harmless the Village and its agents, officers, and employees, against all injuries, deaths, strikes, losses, damages, claims, suits, liabilities, judgments, costs and expenses, which may arise directly or indirectly from any negligence or from the reckless or willful misconduct of the Contractor, its employees, or its subcontractors.
- 33.2 The Contractor shall at its own expense, appear, defend and pay all charges of attorneys and all costs and other expenses arising therefrom or incurred in connection therewith, and, if any judgment shall be rendered against the Village in any such action, the Contractor shall, at its own expense, satisfy and discharge the same. This agreement shall not be construed as requiring the Contractor to indemnify the Village for its own negligence. The Contractor shall indemnify, keep and save harmless the Village only where a loss was caused by the negligent, willful or reckless acts or omissions of the Contractor, its employees, or its subcontractors.

34. SUBLETTING OF CONTRACT

- 34.1 No contract awarded by the Village shall be assigned or any part subcontracted without the written consent of the Village. In no case shall such consent relieve the Contractor from his obligation or change the terms of this Contract.

All approved subcontracts shall contain language which incorporates the terms and conditions of this Contract.

35. TERMINATION OF CONTRACT

- 35.1 The Village reserves the right to terminate the whole or any part of this Contract, upon written notice to the Contractor, for any reason.
- 35.2 The Village further reserves the right to terminate the whole or any part of this Contract, upon written notice to the Contractor, in the event of default by the Contractor. Default is defined as failure of the Contractor to perform any of the provisions of this Contract or failure to make sufficient progress so as to endanger performance of this Contract in accordance with its terms.

In the event that the Contractor fails to cure the default within the timeframe provided in the notice, and the Village declares default and termination, the Village may procure, upon such terms and in such manner as it may deem appropriate, supplies or services similar to those so terminated. The Village may also contact the issuer of the Performance Bond to complete the Work. The Contractor shall be liable for any excess costs for such similar supplies or services. Any such excess costs incurred by the Village may be set-off against any monies due and owing by the Village to the Contractor.

36. BILLING AND PAYMENT PROCEDURES

36.1 Payment will be made upon receipt of an invoice referencing Village purchase order number. Once an invoice and receipt of materials or service have been verified, the invoice will be processed for payment in accordance with the Village's payment schedule. The Village will comply with the Local Government Prompt Payment Act, 50 ILCS 505/1 et seq., in that any bill approved for payment must be paid or the payment issued to the Contractor within 60 days of receipt of a proper bill or invoice. If payment is not issued to the Contractor within this 60 day period, an interest penalty of 1.0% of any amount approved and unpaid shall be added for each month or fraction thereof after the end of this 60 day period, until final payment is made.

36.2 The Village shall review each bill or invoice in a timely manner after its receipt. If the Village determines that the bill or invoice contains a defect making it unable to process the payment request, the Village shall notify the Contractor as soon as possible after discovering the defect pursuant to rules promulgated under 50 ILCS 505/1 et seq. The notice shall identify the defect and any additional information necessary to correct it.

36.3 As this Contract is for work defined as a "fixed public work" project under the Illinois Prevailing Wage Act, 820 ILCS 130/2, any contractor or subcontractor is required to submit certified payroll records along with the invoice. No invoice shall be paid without said records.

36.4 Please send all invoices to the attention of: Village of Downers Grove, Accounts Payable, 801 Burlington, Downers Grove, IL 60515.

37. COMPLIANCE WITH OSHA STANDARDS

37.1 Equipment supplied to the Village must comply with all requirements and standards as specified by the Occupational Safety and Health Act. All guards and protectors as well as appropriate markings will be in place before delivery. Items not meeting any OSHA specifications will be refused.

38. CERCLA INDEMNIFICATION

38.1 The Contractor shall, to the maximum extent permitted by law, indemnify, defend, and hold harmless the Village, its officers, employees, agents, and attorneys from and against any and all liability, including without limitation, costs of response, removal, remediation, investigation, property damage, personal injury, damage to natural resources, health assessments, health settlements, attorneys' fees, and other related transaction costs arising under the Comprehensive Environmental Response, Compensation, and Liability Act (CERCLA) of 1980, 42 U.S.C.A. Sec. 9601, et seq., as amended, and all other applicable statutes, regulations, ordinances, and under common law for any release or threatened release of the waste material collected by the Contractor, both before and after its disposal.

38.2 If the Contractor encounters any waste material governed by the above Act, it shall immediately notify the Village and stop working in the area until the above requirements can be met.

39. COPYRIGHT or PATENT INFRINGEMENT

39.1 The Contractor agrees to indemnify, defend, and hold harmless the Village against any suit, claim, or proceeding brought against the Village for alleged use of any equipment, systems, or services provided by the Contractor that constitutes a misuse of any proprietary or trade secret information or an infringement of any patent or copyright.

40. BUY AMERICA

40.1 The Contractor agrees to comply with 49 U.S.C.5323(j), the Federal Transportation Administration's (FTA) Buy America regulations at 49 C.F.R. Part 661, and any amendments thereto, and any implementing guidance issued by the FTA, with respect to this Contract, when financed by Federal funds (through a grant agreement or cooperative agreement).

40.2 As a condition of responsiveness, the Contractor agrees to submit with its Bid submission, an executed Buy America Certificate, attached hereto.

41. CAMPAIGN DISCLOSURE

41.1 Any contractor, proposer, bidder or vendor who responds by submitting a bid or proposal to the Village of Downers Grove shall be required to submit with its bid submission, an executed Campaign Disclosure Certificate, attached hereto.

41.2 The Campaign Disclosure Certificate is required pursuant to the Village of Downers Grove Council Policy on Ethical Standards and is applicable to those campaign contributions made to any member of the Village Council.

41.3 Said Campaign Disclosure Certificate requires any individual or entity bidding to disclose campaign contributions, as defined in Section 9-1.4 of the Election Code (10 ILCS 5/9-1.4), made to current members of the Village Council within the five (5) year period preceding the date of the bid or proposal release.

41.4 By signing the bid documents, contractor/proposer/bidder/vendor agrees to refrain from making any campaign contributions as defined in Section 9-1.4 of the Election Code (10 ILCS 5/9-1.4) to any Village Council member and any challengers seeking to serve as a member of the Downers Grove Village Council.

42. GUARANTEE PERIOD

42.1 The Contractor shall provide a guarantee in writing covering a minimum period of one (1) year after approval and acceptance of the Work. The Guarantee shall be in such form as the Village may prescribe, unless otherwise noted in the Specifications, and shall be submitted before receiving final payment. If longer guarantees are required, they will be noted in the Special Provisions for this project.

43. SUCCESSORS AND ASSIGNS

43.1 The terms of this Contract will be binding upon and inure to the benefit of the parties and their respective successors and assigns; provided, however, that neither party will assign this Contract in whole or in part without the prior written approval of the other. The Contractor will provide a list of key staff, titles, responsibilities, and contact information to include all expected subcontractors.

44. WAIVER OF BREACH OF CONTRACT

44.1 The waiver by one party of any breach of this Contract or the failure of one party to enforce at any time, or for any period of time, any of the provisions hereof will be limited to the particular instance and will not operate or be deemed to waive any future breaches of this Contract and will not be construed to be a waiver of any provision except for the particular instance.

45. CHANGE ORDERS

45.1 The contract price is a "not-to-exceed" cost. At any time additional work is necessary or requested, and the not-to-exceed price is increased thereby, all parties must agree to any change, addition or price increase in writing.

45.2 Change orders for public works projects which authorize an increase in the contract price that is 50% or more of the original contract price or that authorize or necessitate any increase in the price of a subcontract under the contract that is 50% or more of the original subcontract price must be resubmitted for bidding in the same manner by which the original contract was bid. (50 ILCS 525/1)

46. SEVERABILITY OF INVALID PROVISIONS

46.1 If any provisions of this Contract are held to contravene or be invalid under the laws of any state, country or jurisdiction, contravention will not invalidate the entire Contract, but it will be construed as if not containing the invalid provision and the rights or obligations of the parties will be construed and enforced accordingly.

47. GOVERNING LAW

47.1 This Contract will be governed by and construed in accordance with the laws of the State of Illinois. Venue is proper only in the County of DuPage for state cases or the Northern District of Illinois for federal cases.

48. NOTICE

48.1 Any notice will be in writing and will be deemed to be effectively served when deposited in the mail with sufficient first class postage affixed, and addressed to the party at the party's place of business. Notices shall be addressed to the Village as follows:

**Village Manager
Village of Downers Grove
801 Burlington Ave.
Downers Grove, IL 60515**

And to the Contractor as designated on the Contract Form.

49. AMENDMENT

49.1 This Contract will not be subject to amendment unless made in writing and signed by all parties.

50. COOPERATION WITH FOIA COMPLIANCE

50.1 Contractor acknowledges that the Freedom of Information Act may apply to public records in possession of the Contractor or a subcontractor. Contractor and all of its subcontractors shall cooperate with the Village in its efforts to comply with the Freedom of Information Act. 5 ILCS 140/1 et.seq.

51. EMPLOYMENT OF ILLINOIS WORKERS ON PUBLIC WORKS ACT

51.1 If the work contemplated by this Contract is funded or financed in whole or in part with State Funds or funds administered by the State, Contractor agrees to comply with the terms of the Employment of Illinois Workers on Public Works Act by employing at least 90% Illinois laborers on the project. 30 ILCS 570/1 et seq. Contractor agrees further to require compliance with this Act by all of its subcontractors.

III. GENERAL PROVISIONS

1. STANDARD SPECIFICATIONS

- 1.1 The following standards shall govern the construction of the proposed improvements:
 - 1.1.1 Standard Specifications for Water and Sewer Main Construction in Illinois, Sixth Edition, 2009 (the Water & Sewer Specs.); and
 - 1.1.2 Standard Specifications for Road and Bridge Construction as adopted by the Illinois Department of Transportation, January 1, 2012; along with Supplemental Specifications and Recurring Special Provisions (collectively the "SSRBC") as adopted by the Illinois Department of Transportation, January 1, 2013; and
 - 1.1.3 Water Distribution Specifications, Village of Downers Grove, Illinois, revised March, 2006.
- 1.2 These Contract Documents shall take precedence whenever there are conflicts in the wording or statements made by the above specifications and these Contract Documents.
- 1.3 Unless otherwise referenced herein, Division I of the Water and Sewer Specs and Section 102 and Articles 104.02, 104.03, 104.07, 107.02, 107.27, 107.35, 108.10, 108.11, and 108.12 of the SSRBC are hereby suspended.

2. COOPERATION OF CONTRACTOR

- 2.1 The Contractor will be supplied with a minimum of 2 sets of approved plans and contract assemblies including Special Provisions, one set of which the Contractor shall keep available on the work site at all times. The Contractor shall give the work site constant attention necessary to facilitate the progress thereof, and shall cooperate with the Village in every way possible.
- 2.2 The Contractor shall have on the work site at all times, as the Contractor's agent, a competent English-speaking representative capable of reading and thoroughly understanding the Contract Documents, and thoroughly experienced in the type of work being performed. The representative shall also be capable of receiving instruction from the Village, and shall have full authority to promptly respond to such instruction. He shall be capable of supplying such materials, equipment, tools, labor and incidentals as may be required. The Contractor shall not replace him without prior written notification to the Village.

3. LEGAL REGULATIONS AND RESPONSIBILITY TO THE PUBLIC

- 3.1 Section 107 of the SSRBC shall govern the Contractor's legal regulations and responsibility to the public, with the following additions:
 - 3.1.1 **PROJECT SAFETY.** Add the following to Article 107.28:
 - 3.1.1.1 The Contractor shall conduct his work in such a manner as to provide an environment consistent with the safety, health and well being of those engaged in the completion of the Work specified in this Contract.

Village of Downers Grove

- 3.1.1.2 The Contractor shall comply with all State and Federal Safety Regulations as outlined in the latest revisions of the Federal Construction Safety Standards (Series 1926) and with applicable provisions and/or regulations of the Occupation Safety and Health Administration (OSHA) and Standards of the Williams-Stelger Occupational Health Safety Act of 1970 (Revised). **SPECIAL ATTENTION SHALL BE PAID TO COMPLIANCE WITH OSHA'S SUBPART P – EXCAVATIONS STANDARD.**
- 3.1.1.3 The Contractor and Village shall each be responsible for their own respective agents and employees.
- 3.1.2 **BACKING PRECAUTIONS.** Pursuant to Sections 14-139(b) and 14-171.1 of the Downers Grove Municipal Code, any motor vehicle which has an obstructed view to the rear and is to be operated at any time in reverse gear on the public streets of the Village by the Contractor or any subcontractor shall either be equipped with a reverse signal alarm (backup alarm) audible above and distinguishable from the surrounding noise level, or shall provide an observer to signal that it is safe to back up.
- 3.1.3 **OVERWEIGHT, OVERWIDTH AND OVERHEIGHT PERMITS.** The Village has and supports an overweight truck enforcement program. Contractors are required to comply with weight requirements and safety requirements as established by Illinois Law or Village Ordinance, for vehicles, vehicle operators and specialty equipment. In some instances, specialty equipment for road repairs or construction projects requires the movement of overweight, overwidth, or overheight loads utilizing a Village roadway. Such movement will require obtaining a permit from the Village Police Department's Traffic Supervisor.
- 3.1.4 **BARRICADES AND WARNING SIGNS.** The Contractor shall provide the Village with a telephone number of a person or company who is available 24 hours per day, seven days per week, to erect additional barricades or signs. If the Village or its representative deems it necessary for the Public's safety to erect additional barricades or signs during normal working hours, the Contractor will furnish the necessary barricades or signs, and have them in place within 30 minutes. If, after normal working hours, the requested signs are not in place within three hours after the request is made, the Village reserves the right to have the barricades and signs erected. The cost of erecting the barricades and signs shall be deducted by the Village from any payments due the Contractor.
- 4. PROSECUTION AND PROGRESS**
- 4.1 Section 108 of the SSRBC shall govern the prosecution and progress of the work, with the following additions:
- 4.1.1 The Contractor shall schedule his work such that all improvements shall be substantially complete within thirty (30) calendar days from the date of the Notice to Proceed. Substantial completion shall mean all work excluding possible full parkway turf restoration. Although actual sod placement may be delayed until more favorable weather conditions, all disturbed turf areas shall be backfilled and dressed and left in a safe and useable condition conducive to possible foot traffic and to the satisfaction of the Village. The completion date will remain binding throughout the duration of the Contract unless revised in writing by the Village.

- 4.1.2 The total duration of disturbance for work related to means of public egress through the project site or access to private property (e.g. removal and replacement of curb and gutters, sidewalks, driveway entrances, etc.) must not exceed ten (10) calendar days. The Contractor may use high-early strength concrete, meeting all specifications herein, **at his own expense** to help meet this requirement.
- 4.1.3 The Contractor shall also make special note of the following work schedule requirements:
(a) See Special Provision **SP-1** for **SCHEDULES AND RESTRICTIONS FOR WORK**.
- 4.1.4 Should the Contractor fail to complete the work on or before the specified completion dates set forth in Sections 4.1.1, 4.1.2 or 4.1.3 or within such extended time as may be allowed, the Contractor shall be liable for liquidated damages in accordance with the applicable sections of Article 108.09 of the SSRBC.
- 4.1.5 Prior to commencing construction, a meeting will be held with the Contractor and the Village. Any questions concerning procedures, general conditions, special provisions, plans or specific items related to the project shall be answered and clarified. No Pre-Construction meeting shall be scheduled until submittals, performance bonds, and certificates of insurance are delivered to, and approved by, the Village.
- 4.1.6 Weekly progress meetings may be required by the Village. If required, the Contractor shall have a capable person, such as a site superintendent or project manager, attend such meetings and be prepared to report on the prosecution of the Work according to the progress schedule. The Village reserves the right to require adjustments to scheduling of work.

5. MEASUREMENT AND PAYMENT

- 5.1 Section 109 of the SSRBC shall govern measurement and payment, with the following additions:
- 5.1.1 Modifies Article 109.07 - Partial payments will be made per Section 36 of Part II of this document (Billing and Payment Procedures.)
- 5.1.2 The Village will require that partial and final affidavits for all labor, materials and equipment used on the Project, be submitted with the partial and final payment requests. Such waivers shall indicate that charges for all labor, materials and equipment used on the project have been paid. Partial waivers from suppliers and subcontractors may be submitted after the first payment to the Contractor, and before the subsequent payment to that which they apply. However, partial waivers from the Contractor must accompany the invoice of the payment to which it applies.

All final waivers, from all suppliers and subcontractors **MUST** accompany the Contractor's invoice upon submittal for final payment. A sworn statement by the Contractor shall accompany full waivers. Such requirement for full waivers is solely for the benefit of the Village and shall not be construed to benefit any other person. Partial payment for work done shall in no way imply acceptance of the work to that date.

IV. SPECIAL PROVISIONS

The following Special Provisions shall modify, supercede, or supplement the Standard Specifications referred to in Section III - General Provisions.

Where any section, subsection, paragraph, or subparagraph of the Standard Specifications is *supplemented* by any of the following paragraphs, the provisions of such section, subsection, paragraph, or subparagraph shall remain in effect. The Special Provisions shall govern in addition to the particular Standard Specification so supplemented, and not in lieu thereof.

Where any section, subsection, paragraph, or subparagraph of the Standard Specifications is *amended, voided, or superceded* by any of the following paragraphs, any provision of such section, subsection, paragraph, or subparagraph standing unaffected, shall remain in effect. The Special Provisions shall govern in lieu of any particular provision of the Standard Specification so amended, voided, or superceded, and not in addition to the portion changed.

SCOPE OF WORK

Work involves removing public sidewalk trip hazards within Village rights-of-way at various locations on various streets by method of saw cutting. See attached list and corresponding map for locations. The Contractor shall saw cut sidewalk trip hazards at locations designated and within the criteria established by these specifications.

QUALIFICATIONS OF CONTRACTOR

In addition to the requirements set forth in Section 10.1 above, any contractor submitting a bid on this project must demonstrate competence, reliability, and be actively engaged in this specific type of work. The contractor must demonstrate competence prior to submitting a bid by including a history and references, listing completion dates, and submitting bonding information from prior projects, and/or performing an on-site demonstration of their capacity to perform the work as required. The Village reserves the right to disqualify a bid and/or contractor if they are deemed not to be competent or reliable. The Village also reserves the right to select the bid deemed to be most advantageous to the Village.

SP-1 SCHEDULES AND RESTRICTIONS

Description: The Contractor shall submit a schedule showing anticipated dates for work. **The Village reserves the right to require adjustments to scheduling of work.** The Contractor shall also make special note of the following requirements.

All construction work specified under this contract shall be so engaged as to not impede normal traffic and pedestrian ways. Any barricading to detour traffic must receive prior approval from the Engineer.

Special consideration to hours and location of work near schools shall be made to allow for full and safe access during normal student arrival and departure schedules.

Unless otherwise directed by the Engineer, all construction work shall be done such that continuous access to schools or businesses is maintained. Access to residential property may be temporarily curtailed during the hours of 8:00 a.m. to 7:00 p.m. local time only when necessitated by work in progress immediately adjacent to driveways.

However, in all cases, unless otherwise directed by the Engineer, total access must be restored to all types of properties over weekends and legal holidays (7:00 p.m. local time Friday to 8:00 a.m. local time Monday, or until 8:00 a.m. local time the day following a legal holiday).

These requirements shall be considered **INCIDENTAL** to the contract.

SP-2 SAWING CRITERIA

Description: Only sidewalk squares with the following criteria shall be cut.

1. Sidewalk squares with an offset of 3/8 inch or greater.
2. Cross-cuts on any adjacent sidewalk that contain deficiencies outside the listed criteria.
3. Sidewalk squares containing cracks less than 1/2 inch wide with an offset within the above criteria.
4. Curb ramps on the sidewalk side and not the curb.

SP-3 PUBLIC CONVENIENCE AND SAFETY

1. The Contractor shall schedule the operations so as to cause minimum interruption, interference or disturbance to the operation of residents, businesses, schools, churches, etc., and to allow access by pedestrians, emergency, delivery and service vehicles at all times.
2. The Contractor shall properly barricade the work area with traffic cones and lights for any nighttime work. Sidewalk repair equipment and all other items incidental to the work shall not be left or stored on the sidewalk or private property.
3. Any temporary shutdown of existing services or access, as may be required, shall be performed only at such times and for such duration as agreed to by the Engineer. The interruption of services and access shall be conducted in accordance to a plan mutually agreed to between the Engineer and Contractor.
4. Access to all driveways within the project limits shall be maintained whenever possible.
5. Gasoline or diesel operated equipment shall be equipped with mufflers and insulators to minimize noise.

SP-4 LIMITATIONS OF OPERATIONS

1. **GRINDING OF SIDEWALKS TO REMOVE TRIP HAZARDS SHALL NOT BE ALLOWED.**
2. No storing of equipment or materials on the sidewalk or private property shall be allowed without prior approval of the Engineer.
3. All sidewalk saw cuts started in residential areas shall be completed by the end of the same work day in which they are started. Sidewalk saw cutting through driveways of adjoining business properties shall be completed within two (2) hours.

4. The Engineer may direct saw cuts at locations other than construction joints. Saw cuts directed by the Engineer will be paid for at the contract unit price bid.
5. Saw cutting shall be done by a means that will eliminate any dust. Any debris from sawing shall be removed from the sidewalk and/or pavement to reduce possible tracking.
6. No water-cooling, which creates slurry, is allowed.
7. Air borne concrete dust resulting from the cutting process shall be controlled with saw-mounted vacuum hoods equipped with HEPA A type filters. Before mobilizing to the next saw cutting location, all debris, cuttings, and concrete dust shall be immediately swept clean and removed from the sidewalk surface and adjacent sidewalk, rail, driveway, landscaping, building face, and/or other objects in the vicinity of the work.

SP-5 SAW CUTTING OF SIDEWALKS, DRIVEWAYS, AND CURBS - DESCRIPTION

1. The Contractor shall take precautions during saw cutting operations to not disfigure, scar, impair or damage any surrounding surfaces including, but not limited to, sidewalk, driveway, roadway, steps, walls, railings, light poles, turf or any public or private installations such as trees, irrigation sprinkler heads, electric fences, etc.
2. All trip hazards marked for saw cutting must be removed in accordance with the American with Disabilities Act (ADA) requirements with the resulting finish being ADA compliant. Each offset must be tapered at a 1:8 slope and must have smooth uniform appearance and texture.
3. The finished surface shall have a coefficient of friction of at least 0.6.
4. The finished result of each cut shall be taken to a zero point of differential settlement along the entire length of the cut and to both edges of the sidewalk to eliminate trip hazards the full width of the sidewalk.
5. Existing concrete, asphalt mixes, or other types of material used to shim raised sidewalks shall be removed from adjacent sidewalk stones prior to saw cutting sidewalk.

EQUIPMENT

All sidewalk cutting shall be done with diamond-tipped blades and saws capable of cutting at any angle and able to remove the concrete completely to all edges of the sidewalk. The flush-cutting concrete saw shall have a saw-mounted vacuum hood equipped with HEPA A type filters.

Method of Measurement: Saw cutting of sidewalk will be measured for payment in inch-feet of sidewalk cut. The cost of cleaning sidewalk shall be included in the price bid for saw cutting. The quantity of sidewalk cut will be determined by multiplying the average sidewalk trip hazard height times the length of saw cut along the joint on each trip hazard in inch-feet. The Contractor is required to record and submit, with each invoice, the exact dimensions of each trip hazard removed per location. Depth shall be measured to the nearest 1/8 inch.

Village of Downers Grove

Basis of Payment: This work shall be paid for at the contact unit price per **INCH-FEET** for:

SAW CUTTING SIDEWALK, SPECIAL,

which price shall be payment in full for all labor, equipment, tools, materials, mobilizations, and all other costs associated with such work as specified herein.

LOC. NO.	PRELIMINARY LIST OF ADDRESSES	# OF CUTS	NOTES
1	2753 Curtiss Street	2	
2	4536 Elm Street	2	
3	4540 Elm Street	2	
4	4601 Elm Street	1	
5	4610 Elm Street	2	
6	4620 Elm Street	1	
7	4621 Elm Street	1	
8	4625 Elm Street	1	
9	4629 Elm Street	2	
10	4704 Elm Street	3	
11	4716 Elm Street	1	
12	4717 Elm Street	1	
13	4723 Elm Street	1	
14	4724 Elm Street	1	
15	4731 Elm Street	1	
16	4737 Elm Street	1	
17	4804 Elm Street	1	
18	4812 Elm Street	1	
19	4835 Elm Street	1	
20	4839 Elm Street	1	
21	4910 Elm Street	1	
22	4917 Elm Street	1	
23	4922 Elm Street	1	
24	4926 Elm Street	2	
25	5118 Elmwood Avenue	1	
26	5122 Elmwood Avenue	2	
27	5126 Elmwood Avenue	1	
28	5130 Elmwood Avenue	2	
29	5134 Elmwood Avenue	1	
30	5142 Elmwood Avenue	1	
31	7101 Fairmount Avenue	1	
32	5131 Fairmount Avenue	1	on Fairmount Avenue side.
33	5217 Fairmount Avenue	1	on Randall Street side.
34	5221 Fairmount Avenue	1	on Randall Street side.
35	5325 Fairmount Avenue	2	on Summit Street side.
36	5232 Fairmount Avenue	1	
37	5236 Fairmount Avenue	1	
38	5248 Fairmount Avenue	1	

Village of Downers Grove

LOC. NO.	PRELIMINARY LIST OF ADDRESSES	# OF CUTS	NOTES
39	5256 Fairmount Avenue	1	
40	5402 Fairmount Avenue	2	
41	5422 Fairmount Avenue	1	
42	5428 Fairmount Avenue	2	
43	5440 Fairmount Avenue	2	on Fairmount Avenue side.
44	5441 Fairmount Avenue	3	on Fairmount Avenue side.
45	5433 Fairmount Avenue	3	
46	5429 Fairmount Avenue	2	
47	5409 Fairmount Avenue	1	
48	5309 Fairmount Avenue	1	
49	5811 Fairmount Avenue	1	
50	5747 Fairmount Avenue	1	
51	5721 Fairmount Avenue	1	
52	5627 Fairmount Avenue	2	
53	5545 Fairmount Avenue	1	
54	5541 Fairmount Avenue	1	
55	5500 Fairmount Avenue	2	on Fairmount Avenue side.
56	5524 Fairmount Avenue	1	
57	5530 Fairmount Avenue	2	
58	5550 Fairmount Avenue	2	
59	5600 Fairmount Avenue	2	
60	5616 Fairmount Avenue	2	
61	5626 Fairmount Avenue	4	
62	5732 Fairmount Avenue	1	
63	5740 Fairmount Avenue	1	
64	5750 Fairmount Avenue	1	
65	5808 Fairmount Avenue	2	
66	5824 Fairmount Avenue	1	
67	6624 Fairmount Avenue	1	
68	7101 Fairmount Avenue	1	on Fairmount Avenue side.
69	625 Fairmount Avenue	2	1 on 72nd Court side and 1 on Fairmount Avenue side.
70	7 th Street & Fairview Avenue	4	on 7th Street side.
71	5153 Fairview Avenue	3	
72	4631 Fairview Avenue	2	on Indianapolis side.
73	4621 Fairview Avenue	2	on Indianapolis Avenue side.
74	5415 Fairview Avenue	2	on Fairview Avenue side.
75	8 th Street & Fairview Avenue	1	on 8th Street side.
76	6014 Fairview Avenue	2	
77	5813 Fairview Avenue	1	near fire hydrant.
78	5528 Fairview Avenue	1	near tree.
79	5510 Fairview Avenue	1	
80	5612 Fairview Avenue	1	
81	5636 Fairview Avenue	1	

Village of Downers Grove

LOC. NO.	PRELIMINARY LIST OF ADDRESSES	# OF CUTS	NOTES
82	5638 Fairview Avenue	1	near fire hydrant.
83	5724 Fairview Avenue	1	
84	5407 Fairview Avenue	5	
85	5207 Fairview Avenue	2	
86	4850 Fairview Avenue	2	on Franklin Street side.
87	4436 Fairview Avenue	1	on Davis Street side.
88	Davis Street & Fairview Avenue	2	on Davis Street side.
89	4528 Fairview Avenue	1	on Otis Street side.
90	Lincoln Avenue & Fairview Avenue	5	on Lincoln Avenue side.
91	4528 Fairview Avenue	1	
92	5724 Fairview Avenue	1	
93	5712 Fairview Avenue	2	
94	5732 Fairview Avenue	1	
95	5826 Fairview Avenue	1	
96	NW Cor. Fairview Avenue & 57th Street	1	on Fairview Avenue side.
97	5708 Fairview Avenue	2	on 57th Street side & Fairview Avenue side.
98	749 Farley Place	2	
99	751 Farley Place	1	
100	744 Farley Place	1	
101	5324 Florence Avenue	4	on 6th Street side.
102	SE Cor. Florence Avenue	1	on 6th Street side.
103	5128 Florence Avenue		on Florence Avenue side.
104	5201 Florence Avenue	2	on 4th Street side.
105	5214 Florence Avenue	1	on Florence Avenue side.
106	4944 Florence Avenue	2	
107	4953 Florence Avenue	2	on Florence Avenue side.
108	4937 Florence Avenue	1	on Chicago Avenue side.
109	4702 Florence Avenue	2	on Indianapolis Avenue side.
110	241 Florence Avenue	1	
111	5431 Florence Avenue	3	
112	5421 Florence Avenue	5	on Florence Avenue side.
113	5401 Florence Avenue	3	on Florence Avenue side.
114	5335 Florence Avenue	3	
115	5329 Florence Avenue	4	on Florence Avenue side.
116	5325 Florence Avenue	3	
117	5305 Florence Avenue	3	on Florence Avenue side.
118	5301 Florence Avenue	3	
119	5207 Florence Avenue	2	
120	5201 Florence Avenue	5	on Florence Avenue side.
121	5224 Florence Avenue	3	on Florence Avenue side.
122	5234 Florence Avenue	1	on Florence Avenue side.
123	5328 Florence Avenue	3	
124	5330 Florence Avenue	1	
125	5141 Florence Avenue	10	on 3rd Street side.
126	NE Cor. Florence Avenue & 5th Street	3	on Florence Avenue side.

Village of Downers Grove

LOC. NO.	PRELIMINARY LIST OF ADDRESSES	# OF CUTS	NOTES
127	SW Cor. Florence Avenue & 5th Street	1	on Florence Avenue side.
128	NW Cor. Florence Avenue & 6th Street	1	on Florence Avenue side.
129	NW Cor. Florence Avenue & 7th Street	2	on Florence Avenue side.
130	5021 Florence Avenue Unit #1	2	on Burlington Avenue side.
131	4530 Forest Avenue	1	
132	4532 Forest Avenue	1	
133	4537 Forest Avenue	1	
134	4540 Forest Avenue	1	
135	4601 Forest Avenue	1	
136	4605 Forest Avenue	2	1 square across driveway
137	4608 Forest Avenue	3	
138	4613 Forest Avenue	2	
139	4616 Forest Avenue	2	
140	4625 Forest Avenue	1	
141	4628 Forest Avenue	1	
142	4633 Forest Avenue	1	
143	4645 Forest Avenue	2	
144	215 Foxfire Court	1	
145	213 Foxfire Court	1	
146	SW Cor. Foxfire Court & Cumnor Road	1	on Foxfire Court side.
147	414 Franklin Street	4	
148	432 Franklin Street	1	
149	441 Franklin Street	1	
150	501 Franklin Street	1	on Franklin Street side.
151	522 Franklin Street	2	
152	600 Franklin Street	1	
153	614 Franklin Street	1	
154	615 Franklin Street	1	
155	619 Franklin Street	2	
156	627 Franklin Street	1	
157	702 Franklin Street	2	
158	713 Franklin Street	1	
159	717 Franklin Street	1	
160	735 Franklin Street	2	
161	807 Franklin Street	1	
162	819 Franklin Street	1	
163	836 Franklin Street	4	
164	917 Franklin Street	3	
165	921 Franklin Street	2	
166	303 Gierz Avenue	1	
167	424 Gierz Street	1	
168	500 Gierz Street	3	on Gierz Street side.
169	632 Gierz Street	1	
170	509 Gierz Street	4	
171	1441 Gilbert Ave	1	favoring W. edge of property line.

Village of Downers Grove

LOC. NO.	PRELIMINARY LIST OF ADDRESSES	# OF CUTS	NOTES
172	430 Glendenning Road	1	
173	5341 Grand Avenue	3	
174	5333 Grand Avenue	2	
175	5329 Grand Avenue	2	
176	5313 Grand Avenue	3	
177	5309 Grand Avenue	8	
178	5253 Grand Avenue	4	
179	5219 Grand Avenue	1	
180	5215 Grand Avenue	4	
181	5151 Grand Avenue	1	
182	5143 Grand Avenue	1	
183	5129 Grand Avenue	1	
184	5113 Grand Avenue	1	
185	5109 Grand Avenue	1	
186	5100 Grand Avenue	1	on Grand Avenue side.
187	5116 Grand Avenue	2	
188	5724 Grand Avenue	1	
189	5128 Grand Avenue	1	
190	5132 Grand Avenue	2	
191	5140 Grand Avenue	5	
192	5148 Grand Avenue	1	
193	5200 Grand Avenue	1	
194	5252 Grand Avenue	1	
195	5316 Grand Avenue	3	
196	5322 Grand Avenue	3	
197	5328 Grand Avenue	1	
198	5332 Grand Avenue	1	
199	5100 Grand Avenue	3	on Burlington Avenue side.
200	5902 Grand Avenue	1	on 59th Street side.
201	5712 Grand Avenue	4	on 57th Street side.
201	5712 Grand Avenue	3	
202	5724 Grand Avenue	1	
203	5732 Grand Avenue	2	
204	5727 Grand Avenue	2	
205	5725 Grand Avenue	2	
206	5922 Grand Avenue	1	
207	5930 Grand Avenue	1	
208	6135 Grand Avenue	1	
209	SE Cor. Grand Avenue & Hill Street	3	on Grand Avenue side.
210	SW Cor. Grand Avenue & Hill Street	2	house on southwest corner on Grand Avenue side.
211	404 Grant Street	1	
212	405 Grant Street	1	
213	409 Grant Street	2	
214	410 Grant Street	2	

Village of Downers Grove

LOC. NO.	PRELIMINARY LIST OF ADDRESSES	# OF CUTS	NOTES
215	414 Grant Street	2	
216	415 Grant Street	1	
217	420 Grant Street	2	
218	421 Grant Street	2	
219	422 Grant Street	2	
220	424 Grant Street	4	
221	435 Grant Street	2	
222	438 Grant Street	1	
223	502 Grant Street	3	
224	524 Grant Street	3	
225	528 Grant Street	1	
226	530 Grant Street	2	
227	602 Grant Street	1	
228	606 Grant Street	1	
229	621 Grant Street	1	
230	705 Grant Street	1	
231	711 Grant Street	1	
232	727 Grant Street	2	
233	731 Grant Street	1	
234	735 Grant Street	2	
235	800 Grant Street	2	
236	903 Grant Street	1	
237	920 Grant Street	1	
238	933 Grant Street	1	
239	1205 Grant Street	1	
240	1323 Grant Street	1	
241	1436 Grant Street	3	
242	1433 Grant Street	1	
243	4501 Grant Street	1	5' west of entrance steps to church.
244	3924 Highland Avenue	1	
245	4029 Highland Avenue	2	
246	4039 Highland Avenue	1	
247	4042 Highland Avenue	2	
248	4101 Highland Avenue	1	
249	4109 Highland Avenue	1	
250	4124 Highland Avenue	1	
251	4133 Highland Avenue	1	
252	4136 Highland Avenue	2	
253	4141 Highland Avenue	1	
254	4230 Highland Avenue	1	on 41st Street side.
255	4236 Highland Avenue	2	on Highland Avenue side.
256	4237 Highland Avenue	1	
257	4326 Highland Avenue	1	
258	4334 Highland Avenue	1	
259	4338 Highland Avenue	1	

Village of Downers Grove

LOC. NO.	PRELIMINARY LIST OF ADDRESSES	# OF CUTS	NOTES
260	4341 Highland Avenue	1	
261	4343 Highland Avenue	1	
262	4347 Highland Avenue	1	
263	4407 Highland Avenue	1	
264	4417 Highland Avenue	1	
265	4421 Highland Avenue	1	
266	4425 Highland Avenue	1	
267	4435 Highland Avenue	1	
268	4439 Highland Avenue	2	
269	4443 Highland Avenue	1	
270	4501 Highland Avenue	5	
271	4505 Highland Avenue	2	
272	4513 Highland Avenue	1	
273	4517 Highland Avenue	1	
274	4520 Highland Avenue	1	
275	4521 Highland Avenue	1	
276	4524 Highland Avenue	2	
277	4532 Highland Avenue	1	
278	4533 Highland Avenue	3	
279	4540 Highland Avenue	2	
280	4600 Highland Avenue	5	
281	4603 Highland Avenue	6	
282	4608 Highland Avenue	1	
283	4609 Highland Avenue	1	
284	4612 Highland Avenue	2	
285	4613 Highland Avenue	2	
286	4616 Highland Avenue	1	
287	4625 Highland Avenue	1	
288	4628 Highland Avenue	1	
289	4632 Highland Avenue	4	
290	4636 Highland Avenue	1	
291	4637 Highland Avenue	2	
292	4644 Highland Avenue	2	
293	4706 Highland Avenue	1	
294	4710 Highland Avenue	1	
295	4720 Highland Avenue	1	
296	4726 Highland Avenue	1	
297	4730 Highland Avenue	1	
298	4737 Highland Avenue	1	
299	4800 Highland Avenue	2	
300	4802 Highland Avenue	1	
301	4816 Highland Avenue	2	
302	4900 Highland Avenue	1	
303	4905 Highland Avenue	3	
304	4925 Highland Avenue	1	

Village of Downers Grove

LOC. NO.	PRELIMINARY LIST OF ADDRESSES	# OF CUTS	NOTES
305	4936 Highland Avenue	1	
306	Highland School	8	
307	405 Hill Street	1	
308	413 Hill Street	2	
309	417 Hill Street	3	on Hill Street side.
310	429 Hill Street	1	
311	433 Hill Street	3	
312	Hill Street & Fairview Avenue (NW)	1	
313	Hill Street & Fairview Avenue (SW)	1	
314	5631 Hillcrest Road		
315	2824 Hitchcock Avenue	1	
316	Hitchcock Avenue & Walnut Avenue (SW)	1	
317	215 Indianapolis Avenue	2	at driveway entrance.
318	319 Indianapolis Avenue	1	
319	235 Indianapolis Avenue	3	
320	233 Indianapolis Avenue	2	
321	505 Indianapolis Avenue	1	
322	504 Indianapolis Avenue	4	
323	505 Indianapolis Avenue	3	on Douglas Road side.
324	439 Indianapolis Avenue	4	on Douglas Road side.
325	435 Indianapolis Avenue	2	on Indianapolis Avenue side.
326	431 Indianapolis Avenue	1	
327	425 Indianapolis Avenue	1	
328	421 Indianapolis Avenue	3	
329	419 Indianapolis Avenue	1	
330	415 Indianapolis Avenue	1	
331	402 Indianapolis Avenue	2	
332	410 Indianapolis Avenue	1	
333	418 Indianapolis Avenue	2	on Indianapolis Avenue side.
334	420 Indianapolis Avenue	2	
335	500 Indianapolis Avenue	3	
336	5200 Katrine Avenue	2	
337	3924 Highland Avenue	1	
338	4029 Highland Avenue	2	on Curtiss Street side.
339	4034 Highland Avenue	2	adjacent to parkway tree.
340	4039 Highland Avenue	1	on Powell Street side.
341	4042 Highland Avenue	2	
342	4101 Highland Avenue	1	
343	4109 Highland Avenue	1	
344	4124 Highland Avenue	1	
345	4133 Highland Avenue	1	
346	4136 Highland Avenue	2	
347	4141 Highland Avenue	1	
348	4230 Highland Avenue	1	

Village of Downers Grove

LOC. NO.	PRELIMINARY LIST OF ADDRESSES	# OF CUTS	NOTES
349	4236 Highland Avenue	2	
350	4237 Highland Avenue	1	
351	4326 Highland Avenue	1	
352	4334 Highland Avenue	1	
353	4338 Highland Avenue	1	
354	4341 Highland Avenue	1	
355	4343 Highland Avenue	1	on Lake Avenue side.
356	4347 Highland Avenue	1	
357	4407 Highland Avenue	1	
358	4417 Highland Avenue	1	off of Indianapolis Avenue.
359	4421 Highland Avenue	1	
360	4425 Highland Avenue	1	
361	4435 Highland Avenue	1	
362	4439 Highland Avenue	2	
363	4443 Highland Avenue	1	
364	4501 Highland Avenue	5	
365	4505 Highland Avenue	2	
366	4513 Highland Avenue	1	
367	4517 Highland Avenue	1	
368	4520 Highland Avenue	1	
369	4521 Highland Avenue	1	
370	4524 Highland Avenue	2	
371	4528 Highland Avenue	2	
372	4532 Highland Avenue	2	
373	4533 Highland Avenue	3	
374	4540 Highland Avenue	2	
375	4600 Highland Avenue	5	
376	4603 Highland Avenue	6	
377	4608 Highland Avenue	1	
378	4609 Highland Avenue	1	
379	4612 Highland Avenue	2	
380	4613 Highland Avenue	2	
381	4616 Highland Avenue	1	
382	4624 Highland Avenue	2	
383	4625 Highland Avenue	1	adjacent to b-box.
384	4628 Highland Avenue	1	
385	4632 Highland Avenue	4	
386	4636 Highland Avenue	1	
387	4637 Highland Avenue	2	
388	4644 Highland Avenue	2	
389	4706 Highland Avenue	1	
390	4710 Highland Avenue	1	SW corner of large white house property.
391	4720 Highland Avenue	1	
392	4726 Highland Avenue	1	
393	4730 Highland Avenue	1	

Village of Downers Grove

LOC. NO.	PRELIMINARY LIST OF ADDRESSES	# OF CUTS	NOTES
394	4737 Highland Avenue	1	
395	4800 Highland Avenue	2	
396	4802 Highland Avenue	1	
397	4816 Highland Avenue	2	5 on 41st Street side & 6 on Longmeadow Road side.
398	4900 Highland Avenue	1	
399	4905 Highland Avenue	3	
400	4925 Highland Avenue	1	
401	4936 Highland Avenue	1	
402	Highland School	8	
403	405 Hill Street	1	
404	413 Hill Street	2	
405	417 Hill Street	3	
406	429 Hill Street	1	
407	433 Hill Street	3	
408	Hill Street & Fairview Avenue (NW)	1	
409	Hill Street & Fairview Avenue (SW)	1	
410	5631 Hillcrest Road		
411	2824 Hitchcock Avenue	1	on Tower Road side.
412	Hitchcock Avenue & Walnut Avenue (SWX)	1	on Tower Road side.
413	215 Indianapolis Avenue	2	on Longmeadow side.
414	319 Indianapolis Avenue	1	
415	235 Indianapolis Avenue	3	
416	233 Indianapolis Avenue	2	
417	505 Indianapolis Avenue	1	
418	504 Indianapolis Avenue	4	
419	505 Indianapolis Avenue	3	
420	439 Indianapolis Avenue	4	
421	435 Indianapolis Avenue	2	
422	431 Indianapolis Avenue	1	
423	425 Indianapolis Avenue	1	
424	421 Indianapolis Avenue	3	
425	419 Indianapolis Avenue	1	
426	415 Indianapolis Avenue	1	4 on Longmeadow Road side & 3 on 41st Street side.
427	402 Indianapolis Avenue	2	4 on 41st Street side & 2 on Cumnor Road side.
428	410 Indianapolis Avenue	1	on east side of Highland Avenue.
429	418 Indianapolis Avenue	2	
430	420 Indianapolis Avenue	2	
431	500 Indianapolis Avenue	3	
432	5200 Katrine Avenue	2	
433	404 Lake Avenue	1	on Lyman Avenue side.
434	426 Lake Avenue	1	

Village of Downers Grove

LOC. NO.	PRELIMINARY LIST OF ADDRESSES	# OF CUTS	NOTES
435	434 Lake Avenue	2	on Farley Place side.
436	438 Lake Avenue	1	
437	442 Lake Avenue	3	
438	505 Lake Avenue	1	on Lyman Avenue side.
439	437 Lake Avenue	2	
440	433 Lake Avenue	1	
441	429 Lake Avenue	2	
442	425 Lake Avenue	1	
443	415 Lake Avenue	3	on Summit Street side.
444	405 Lake Avenue	6	on Fairmount Avenue side.
445	Lake Avenue & Fairview Avenue (SWX)	2	on Maple Avenue side.
446	4407 Lee Avenue	1	on Lyman Avenue side.
447	4525 Lee Avenue	1	
448	Lester School	1	
449	212 Lincoln Avenue	1	
450	216 Lincoln Avenue	1	
451	228 Lincoln Avenue	1	
452	240 Lincoln Avenue	1	
453	310 Lincoln Avenue	1	
454	323 Lincoln Avenue	1	
455	412 Lincoln Avenue	2	
456	415 Lincoln Avenue	3	
457	425 Lincoln Avenue	2	
458	426 Lincoln Avenue	2	
459	427 Lincoln Avenue	3	
460	430 Lincoln Avenue	2	
461	432 Lincoln Avenue	1	
462	434 Lincoln Avenue	2	
463	501 Lincoln Avenue	1	
464	505 Lincoln Avenue	2	
465	147 Lincoln Place	1	
466	712 Lincoln Street	1	
467	732 Lincoln Street	1	
468	736 Lincoln Street	1	
469	750 Lincoln Street	2	
470	904 Lincoln Street	3	on Morning Glory side.
471	911 Lincoln Street	1	
472	923 Lincoln Street	1	on Wilcox Avenue side.
473	1016 Lincoln Street	1	across street from 4334 Cumnor Road.
474	1121 Lincoln Street	1	
475	1220 Lincoln Street	1	
476	4209 Lindly Street	1	
477	4217 Lindly Street	1	
478	4244 Lindly Street	1	
479	4342 Linscott Avenue	1	

Village of Downers Grove

LOC. NO.	PRELIMINARY LIST OF ADDRESSES	# OF CUTS	NOTES
480	4533 Linscott Avenue	1	
481	4605 Linscott Avenue	1	
482	4620 Linscott Avenue	2	
483	4621 Linscott Avenue	1	
484	4641 Linscott Avenue	1	
485	Longmeadow Road & Roslyn Road (SEX)	11	on Roslyn Road side.
486	4151 Longmeadow Road	2	on Douglas Road side.
487	4141 Longmeadow Road	1	
488	4131 Longmeadow Road	1	
489	4111 Longmeadow Road	6	
490	4101 Longmeadow Road	1	
491	4051 Longmeadow Road	3	on 59th Street side.
492	4041 Longmeadow Road	1	on Oneill Road side.
493	4031 Longmeadow Road	1	
494	4021 Longmeadow Road	1	
495	4011 Longmeadow Road	1	
496	4001 Longmeadow Road	3	on Hawkins Avenue side.
497	3941 Longmeadow Road	1	
498	3931 Longmeadow Road	2	
499	3921 Longmeadow Road	1	
500	3922 Longmeadow Road	3	
501	3922 Longmeadow Road	1	
502	3932 Longmeadow Road	2	
503	4002 Longmeadow Road	1	
504	4012 Longmeadow Road	6	
505	4022 Longmeadow Road	2	
506	4032 Longmeadow Road	1	
507	4042 Longmeadow Road	1	
508	4052 Longmeadow Road	1	
509	4112 Longmeadow Road	2	
510	4122 Longmeadow Road	2	
511	4132 Longmeadow Road	4	
512	4142 Longmeadow Road	4	
513	4152 Longmeadow Road	6	
514	4162 Longmeadow Road	7	
515	4163 Longmeadow Road	6	
516	Vacant Lot	4	
517	5229 Lyman Avenue	2	on 67th Street side.
518	5310 Lyman Avenue	1	east of 819 Randall Street at Randall Park.
519	5332 Lyman Avenue	2	across street from 748 Randall Street.
520	5420 Lyman Avenue	1	across from 5249 Park Avenue at Randall Park.
521	5436 Lyman Avenue	2	across from 5257 Park Avenue at Randall Park.
522	5429 Lyman Avenue	2	across from 5313 Park Avenue at Randall Park.
523	5413 Lyman Avenue	2	across from 5321 Park Avenue at Randall Park.
524	5512 Lyman Avenue	1	on Summit Street side at Well House.

Village of Downers Grove

LOC. NO.	PRELIMINARY LIST OF ADDRESSES	# OF CUTS	NOTES
525	5618 Lyman Avenue	2	
526	5728 Lyman Avenue	1	
527	5734 Lyman Avenue	1	
528	5736 Lyman Avenue	1	on Park Avenue side.
529	Lyman Avenue & Blanchard Street (SWX)	1	
530	Lyman Avenue & Blanchard Street (NWX)	1	
531	5401 Main Street	1	
532	5004 Maple Avenue	2	
533	847 Maple Avenue	3	on Park Avenue side.
534	4429 Middaugh Avenue	1	
535	4432 Middaugh Avenue	2	on Farley Place side.
536	4505 Middaugh Avenue	1	on Farley Place side.
537	4511 Middaugh Avenue	2	
538	4521 Middaugh Avenue	1	
539	4541 Middaugh Avenue	2	
540	4512 Middaugh Avenue	2	
541	4520 Middaugh Avenue	2	
542	4528 Middaugh Avenue	1	
543	4540 Middaugh Avenue	1	
544	4604 Middaugh Avenue	1	on Powell Place side.
545	4612 Middaugh Avenue	1	
546	4613 Middaugh Avenue	1	
547	4618 Middaugh Avenue	2	
548	4624 Middaugh Avenue	1	on Powell Street side.
549	4628 Middaugh Avenue	1	
550	4633 Middaugh Avenue	1	
551	4637 Middaugh Avenue	1	
552	417 Morning Glory	3	
553	411 Morning Glory	4	
554	519 Morning Glory	1	
555	523 Morning Glory	1	
556	520 Morning Glory	2	
557	410 Morning Glory	5	
558	430 Morning Glory	2	
559	329 Naperville Boulevard	1	
560	north side of south entrance to condos.	1	
561	4500 Oakwood Avenue	3	near Sherman Street & Prince Street
562	4518 Oakwood Avenue	1	near the track field, across from 4434 and 4436 Prince St
563	4522 Oakwood Avenue	1	
564	4600 Oakwood Avenue	1	
565	4601 Oakwood Avenue	1	
566	4607 Oakwood Avenue	1	

Village of Downers Grove

LOC. NO.	PRELIMINARY LIST OF ADDRESSES	# OF CUTS	NOTES
567	4619 Oakwood Avenue	1	
568	4630 Oakwood Avenue	1	
569	4633 Oakwood Avenue	1	
570	4636 Oakwood Avenue	1	
571	250 Ogden Avenue	1	
572	357 Ogden Avenue	1	
573	532 Ogden Avenue	9	
574	725 Ogden Avenue	1	
575	845 Ogden Avenue	2	
576	1001 Ogden Avenue	1	
577	1445 Ogden Avenue	1	
578	YMCA on 59th Street & Fairmount Ave	2	
579	5929 Osage Avenue	3	
580	5921 Osage Avenue	2	
581	5913 Osage Avenue	4	
582	5914 Osage Avenue	1	
583	5928 Osage Avenue	3	
584	6034 Osage Avenue	1	
585	6118 Osage Avenue	1	
586	6201 Osage Avenue	1	
587	6143 Osage Avenue	1	
588	over St. Joe creek at Grand Avenue	3	
589	925 Oxford Avenue	5	
590	Randall Street & Park Avenue	3	
591	Randall Street & Park Avenue	2	
592	Randall Street & Park Avenue	2	
593	Randall Street & Park Avenue	1	
594	Randall Street & Park Avenue	3	
595	Randall Street & Park Avenue	1	
596	5424 Park Avenue	1	
597	5408 Park Avenue	1	
598	5441 Park Avenue	2	
599	5431 Park Avenue	1	
600	5325 Park Avenue	1	
601	5305 Park Avenue	2	
602	5301 Park Avenue	1	
603	5249 Park Avenue	2	
604	5243 Park Avenue	3	
605	5235 Park Avenue	1	
606	5239 Park Avenue	2	
607	5408 Park Avenue	1	
608	5412 Park Avenue	2	
609	6951 Plymouth Road	1	
610	7001 Plymouth Road	2	
611	7010 Plymouth Road	1	

Village of Downers Grove

LOC. NO.	PRELIMINARY LIST OF ADDRESSES	# OF CUTS	NOTES
612	7020 Plymouth Road	4	
613	7021 Plymouth Road	2	
614	7030 Plymouth Road	2	
615	426 Prairie Avenue	1	
616	814 Prairie Avenue	1	
617	832 Prairie Avenue	1	
618	840 Prairie Avenue	3	
619	903 Prairie Avenue	2	
620	904 Prairie Avenue	1	
621	929 Prairie Avenue	1	
622	4326 Prince Street	1	
623	4337 Prince Street	2	
624	4436 Prince Street	2	
625	4506 Prince Street	1	on Roslyn Road side.
626	4520 Prince Street	3	
627	4524 Prince Street	1	
628	4532 Prince Street	2	
	4533 Prince Street	1	
629	4536 Prince Street	1	
630	2002 Prairie Avenue	3	1 of 2 cuts adj. to pkwy sign at NWX of Woodward & Prairie.
631	4537 Prairie Avenue	1	
632	4542 Prairie Avenue	2	
633	4545 Prairie Avenue	1	
634	4549 Prairie Avenue	1	
635	4600 Prairie Avenue	2	
636	4602 Prairie Avenue	1	
637	4603 Prairie Avenue	1	
638	4607 Prairie Avenue	1	
639	4608 Prairie Avenue	1	3 on Roslyn Road side & 2 on Tower Road side.
640	4623 Prairie Avenue	1	
641	4624 Prairie Avenue	1	
642	4640 Prairie Avenue	1	
643	4644 Prairie Avenue	1	
	4715 Prairie Avenue	1	
644	4718 Prairie Avenue	2	
645	4729 Prairie Avenue	2	east of driveway & west edge of HMA driveway.
646	4541 Prince Street	2	
647	4600 Prince Street	1	
648	4605 Prince Street	2	
649	4612 Prince Street	2	on Roslyn Road side.
650	4613 Prince Street	1	on Traube Avenue side.
651	4620 Prince Street	2	

Village of Downers Grove

LOC. NO.	PRELIMINARY LIST OF ADDRESSES	# OF CUTS	NOTES
652	4630 Prince Street	1	
653	4640 Prince Street	1	
654	4646 Prince Street	1	on Roslyn Road side.
655	4644 Prince Street	1	
656	4323 Prospect Avenue	1	
657	4343 Prospect Avenue	2	
658	4400 Prospect Avenue	3	
659	4401 Prospect Avenue	3	
660	4601 Prospect Avenue	1	
661	4800 Prospect Avenue	1	
662	4810 Prospect Avenue	1	
663	4819 Prospect Avenue	2	
664	4820 Prospect Avenue	1	
665	4831 Prospect Avenue	1	
666	4841 Prospect Avenue	1	
667	4910 Prospect Avenue	2	
668	4922 Prospect Avenue	1	
669	4925 Prospect Avenue	2	
670	4929 Prospect Avenue	2	
671	4932 Prospect Avenue	1	
672	4942 Prospect Avenue	1	
673	736 Randall Street	1	
674	430 Rogers Street	3	
675	526 Rogers Street	1	
676	555 Rogers Street	1	
677	602 Rogers Street	1	
678	703 Rogers Street	2	
679	708 Rogers Street	1	
680	727 Rogers Street	1	
681	731 Rogers Street	1	
682	806 Rogers Street	1	
683	829 Rogers Street	1	
684	845 Rogers Street	1	
685	930 Rogers Street	1	
686	4906 Rogers Street	1	
687	4161 Roslyn Road	1	
688	4151 Roslyn Road	2	
689	4131 Roslyn Road	2	
690	4121 Roslyn Road	2	
691	4111 Roslyn Road	1	
692	4101 Roslyn Road	1	
693	4061 Roslyn Road	1	
694	4041 Roslyn Road	1	
695	4031 Roslyn Road	1	
696	4021 Roslyn Road	2	

Village of Downers Grove

LOC. NO.	PRELIMINARY LIST OF ADDRESSES	# OF CUTS	NOTES
697	4011 Roslyn Road	2	
698	4001 Roslyn Road	1	
699	3931 Roslyn Road	2	
700	Roslyn Road (SEX)	2	

TOTAL NUMBER OF CUTS 1,221

V. BID and CONTRACT FORM (Village)

*****THIS BID WHEN ACCEPTED AND SIGNED BY AN AUTHORIZED SIGNATORY OF THE VILLAGE OF DOWNERS GROVE SHALL BECOME A CONTRACT BINDING UPON BOTH PARTIES.**

Entire Form Must Be Completed If a Submitted Bid Is To Be Considered For Award

BIDDER:

SAFE STEP LLC
Company Name

4/10/13
Date

PO Box 411 105 GREENDALE
Street Address of Company

ROB@NOTRIPPIN.COM
E-mail Address

HORTONVILLE, WI 54944
City, State, Zip

ROB STRAUSS
Contact Name (Print)

920-540-7414
Business Phone

920-540-7414
24-Hour Telephone

866-479-1069
Business Fax

Signature of Officer, Partner or Sole Proprietor

ATTEST: if a Corporation

ROB STRAUSS REGIONAL MANAGER
Print Name & Title

Signature of Corporation Secretary

We hereby agree to furnish the Village of Downers Grove all necessary materials, equipment, labor, etc. to complete the project within **30** calendar days from the date of the Notice to Proceed in accordance with the provisions, instructions and specifications for the unit prices shown on the Schedule of Prices.

VILLAGE OF DOWNERS GROVE:

ATTEST:

Authorized Signature

Village Clerk

Title

Date

Date

In compliance with the specifications, the above-signed offers and agrees, if this Bid is accepted within **90** calendar days from the date of opening, to furnish any or all of the services upon which prices are quoted, at the price set opposite each item, delivered at the designated point within the time specified above.

V. BID and CONTRACT FORM (Contractor)

*****THIS BID WHEN ACCEPTED AND SIGNED BY AN AUTHORIZED SIGNATORY OF THE VILLAGE OF DOWNERS GROVE SHALL BECOME A CONTRACT BINDING UPON BOTH PARTIES.**

Entire Form Must Be Completed If a Submitted Bid Is To Be Considered For Award

BIDDER:

SAFE STEP LLC
Company Name

4-10-13
Date

PO BOX 411 105 GREENDALE
Street Address of Company

ROB@NOTRIPPIN.COM
E-mail Address

HORTONVILLE, WI 54944
City, State, Zip

ROB STRAUSS
Contact Name (Print)

920-540-7414
Business Phone

920-540-7414
24-Hour Telephone

866-479-1069
Business Fax

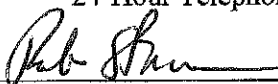
Signature of Officer, Partner or Sole Proprietor

ATTEST: if a Corporation

ROB STRAUSS
Print Name & Title

Signature of Corporation Secretary

We hereby agree to furnish the Village of Downers Grove all necessary materials, equipment, labor, etc. to complete the project within 30 calendar days from the date of the Notice to Proceed in accordance with the provisions, instructions and specifications for the unit prices shown on the Schedule of Prices.

VILLAGE OF DOWNERS GROVE:

ATTEST:

Authorized Signature

Village Clerk

Title

Date

Date

In compliance with the specifications, the above-signed offers and agrees, if this Bid is accepted within 90 calendar days from the date of opening, to furnish any or all of the services upon which prices are quoted, at the price set opposite each item, delivered at the designated point within the time specified above.

Village of Downers Grove

SCHEDULE OF PRICES:

ITEM NO.	PAY ITEM	QUANTITY	UNIT	UNIT PRICE	TOTAL COST
1	SAW CUTTING SIDEWALK, SPECIAL	4,300	IN-FT	\$23.50	\$101,050.00
				TOTAL BID AMOUNT >	\$101,050.00

BIDDER'S CERTIFICATION (page 1 of 3)

With regard to 2013 SIDEWALK REHABILITATION, Bidder SAFE STEP LLC
(Name of Project) (Name of Bidder)

hereby certifies the following:

1. Bidder is not barred from bidding this Contract as a result of violations of Section 720 ILCS 5/33E-3 (Bid Rigging) or 720 ILCS 5/33E-4 (Bid-Rotating);
2. Bidder certifies that it has a written sexual harassment policy in place and full compliance with 775 ILCS 5/2-105(A)(4);
3. Bidder certifies that not less than the prevailing rate of wages as determined by the Village of Downers Grove, DuPage County or the Illinois Department of Labor shall be paid to all laborers, workers and mechanics performing work for the Village of Downers Grove. All bonds shall include a provision as will guarantee the faithful performance of such prevailing wage clause. Bidder agrees to comply with the Illinois Prevailing Wage Act, 820 ILCS 130/1 *et seq.*, for all work completed. Bidder agrees to pay the prevailing wage and require that all of its subcontractors pay prevailing wage to any laborers, workers or mechanics who perform work pursuant to this Contract or related subcontract. Bidder and each subcontractor shall keep or cause to be kept an accurate record of names, occupations and actual wages paid to each laborer, workman and mechanic employed by the Bidder in connection with the contract. This record shall be sent to the Village on a monthly basis along with the invoice and shall be open to inspection at all reasonable hours by any representative of the Village or the Illinois Department of Labor and must be preserved for four (4) years following completion of the contract. Bidder certifies that Bidder and any subcontractors working on the project are aware that filing false payroll records is a Class A misdemeanor and that the monetary penalties for violations are to be paid pursuant to law by the Bidder, contractor and subcontractor. The Village shall not be liable for any underpayments. If applicable: Since this is a contract for a fixed public works project, as defined in 820 ILCS 130/2, Contractor agrees to post at the job site in an easily accessible place, the prevailing wages for each craft or type of worker or mechanic needed to execute the contract or work to be performed;
4. Bidder certifies that it is in full compliance with the Federal Highway Administrative Rules on Controlled Substances and Alcohol Use and Testing, 49 C.F.R. Parts 40 and 382 and that all employee drivers are currently participating in a drug and alcohol testing program pursuant to the Rules;
5. Bidder further certifies that it is not delinquent in the payment of any tax administered by the Department of Revenue, or that Bidder is contesting its liability for the tax delinquency or the amount of a tax delinquency in accordance with the procedures established by the appropriate Revenue Act. Bidder further certifies that if it owes any tax payment(s) to the Department of Revenue, Bidder has entered into an agreement with the Department of Revenue for the payment of all such taxes that are due, and Bidder is in compliance with the agreement.

BIDDER'S CERTIFICATION (page 2 of 3)

BY: ROB STRAUSS
Bidder's Authorized Agent

20-2754406

FEDERAL TAXPAYER IDENTIFICATION NUMBER
or _____
Social Security Number

Subscribed and sworn to before me
this 11 day of April, 2013
Jenni Badtke
Notary Public

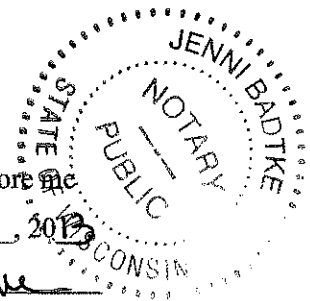

(Fill Out Applicable Paragraph Below)

(a) Corporation

The Bidder is a corporation organized and existing under the laws of the State of _____, which operates under the Legal name of _____, and the full names of its Officers are as follows:

President: _____

Secretary: _____

Treasurer: _____

and it does have a corporate seal. (In the event that this bid is executed by other than the President, attach hereto a certified copy of that section of Corporate By-Laws or other authorization by the Corporation which permits the person to execute the offer for the corporation.)

(b) Partnership

Signatures and Addresses of All Members of Partnership:

[Signature]

[Signature]

BIDDER'S CERTIFICATION (page 3 of 3)

The partnership does business under the legal name of: _____
which name is registered with the office of _____ in the state of _____.

(c) Sole Proprietor

The Bidder is a Sole Proprietor whose full name is: _____
and if operating under a trade name, said trade name is: _____
which name is registered with the office of _____ in the state of _____.

6. Are you willing to comply with the Village's insurance requirements within 13 days of the award of the contract? YES

INSURER'S NAME: AWAY AND ASSOCIATES

AGENT: JAN THOMPSON

Street Address: 201 E. BELL ST.

City, State, Zip Code: NEENAH, WI 54956

Telephone Number: 920-722-7531

I/We hereby affirm that the above certifications are true and accurate and that I/we have read and understand them.

Print Name of Company: SAFE STEP LLC

Print Name and Title of Authorizing Signature: ROB STRAUSS REGIONAL MANAGER

Signature: 

Date: 4/10/13

MUNICIPAL REFERENCE LIST

Municipality: CITY OF GENEVA
 Address: 1800 SOUTH ST GENEVA, IL 60134
 Contact Name: CHRIS BONG Phone #: 630-232-1501
 Name of Project: 2011 GENEVA SAW CUT PROJECT
 Contract Value: \$30,000 Date of Completion: 4-14-11

Municipality: VILLAGE OF DOWNERS GROVE
 Address: 5101 WALNUT AVE DOWNERS GROVE, IL
 Contact Name: BRIAN PARKS Phone #: 630-434-6822
 Name of Project: 2012 SIDEWALK REHABILITATION PROJECT
 Contract Value: \$48,300 Date of Completion: JUNE 2012

Municipality: CITY OF ST. CHARLES
 Address: 1405 S. 7TH ST ST. CHARLES, IL 60174
 Contact Name: JASON BORN Phone #: 630-377-4911
 Name of Project: SAW CUTTING OF SIDEWALKS
 Contract Value: \$40,000 Date of Completion: NOV. 2012

Municipality: VILLAGE OF SCHAUMBURG
 Address: 714 S. PLUM GROVE RD SCHAUMBURG, IL 60193
 Contact Name: BRAD HURBAN Phone #: 847-923-6647
 Name of Project: SAW CUT PROGRAM
 Contract Value: \$20,000 Date of Completion: JULY 2012

Municipality: VILLAGE OF BUFFALO GROVE
 Address: 51 RAUPP BLVD BUFFALO GROVE, IL 60089
 Contact Name: MARK BIEDERWOLF Phone #: 847-459-2523
 Name of Project: SIDEWALK SAW CUT PROJECT
 Contract Value: \$23,000 Date of Completion: JULY 2012

Village of Downers Grove

SUBCONTRACTORS LIST

The Bidder hereby states the following items of work will not be performed by its organization. (List items to be subcontracted as well as the names, addresses and phone numbers of the subcontractors.)

1) N/A Type of Work _____

Addr: _____ City _____ State _____ Zip _____

2) _____ Type of Work _____

Addr: _____ City _____ State _____ Zip _____

3) _____ Type of Work _____

Addr: _____ City _____ State _____ Zip _____

4) _____ Type of Work _____

Addr: _____ City _____ State _____ Zip _____

5) _____ Type of Work _____

Addr: _____ City _____ State _____ Zip _____

6) _____ Type of Work _____

Addr: _____ City _____ State _____ Zip _____

7) _____ Type of Work _____

Addr: _____ City _____ State _____ Zip _____

8) _____ Type of Work _____

Addr: _____ City _____ State _____ Zip _____

Village of Downers Grove

VENDOR W-9 REQUEST FORM



The law requires that we maintain accurate taxpayer identification numbers for all individuals and partnerships to whom we make payments, because we are required to report to the I.R.S all payments of \$600 or more annually. We also follow the I.R.S. recommendation that this information be maintained for all payees including corporations.

Please complete the following substitute W-9 letter to assist us in meeting our I.R.S. reporting requirements. The information below will be used to determine whether we are required to send you a Form 1099. Please respond as soon as possible, as failure to do so will delay our payments.

BUSINESS (PLEASE PRINT OR TYPE):

NAME: SAFE STEP LLC
ADDRESS: PO BOX 411 105 GREENDALE RD
CITY: HORTONVILLE
STATE: WI
ZIP: 54944
PHONE: 920-540-7414 FAX: 866-479-1069
TAX ID #(TIN): 20-2754406

(If you are supplying a social security number, please give your full name)

REMIT TO ADDRESS (IF DIFFERENT FROM ABOVE):

NAME: _____
ADDRESS: _____
CITY: _____
STATE: _____ ZIP: _____

TYPE OF ENTITY (CIRCLE ONE):

- | | |
|----------------------|--|
| Individual | Limited Liability Company - Individual/Sole Proprietor |
| Sole Proprietor | <u>Limited Liability Company-Partnership</u> |
| Partnership | Limited Liability Company-Corporation |
| Medical | Corporation |
| Charitable/Nonprofit | Government Agency |

SIGNATURE: Rob Shames DATE: 4-10-13

Apprenticeship and Training Certification

(Does not apply to federal aid projects. Applicable only to maintenance and construction projects that use Motor Fuel Tax funds or state grant monies.)

Name of Bidder: _____

In accordance with the provisions of Section 30-22 (6) of the Illinois Procurement Code, the Bidder certifies that it is a participant, either as an individual or as part of a group program, in the approved apprenticeship and training programs applicable to each type of work or craft that the bidder will perform with its own forces. The Bidder further certifies for work that will be performed by subcontract that each of its subcontractors submitted for approval either (a) is, at the time of such bid, participating in an approved, applicable apprenticeship and training program; or (b) will, prior to commencement of performance of work pursuant to this Contract, begin participation in an approved apprenticeship and training program applicable to the work of the subcontract. The Illinois Department of Labor, at any time before or after award, may require the production of a copy of each applicable Certificate of Registration issued by the United States Department of Labor evidencing such participation by the contractor and any or all of its subcontractors. Applicable apprenticeship and training programs are those that have been approved and registered with the United States Department of Labor. The Bidder shall list in the space below, the official name of the program sponsor holding the Certificate of Registration for all of the types of work or crafts in which the Bidder is a participant and that will be performed with the Bidder's forces. Types of work or craft work that will be subcontracted shall be included and listed as subcontract work. The list shall also indicate any type of work or craft job category that does not have an applicable apprenticeship or training program. **The Bidder is responsible for making a complete report and shall make certain that each type of work or craft job category that will be utilized on the project is accounted for and listed. Return this with the Bid.**

The requirements of this certification and disclosure are a material part of the Contract, and the Contractor shall require this certification provision to be included in all approved subcontracts. In order to fulfill this requirement, it shall not be necessary that an applicable program sponsor be currently taking or that it will take applications for apprenticeship, training or employment during the performance of the work of this Contract.

Print Name and Title of Authorizing Signature: ROB STRAUSS REGIONAL MANAGER

Signature: 

Date: 4-10-13

Village of Downers Grove

BUY AMERICA CERTIFICATION

Certification requirement for procurement of steel, iron, or manufactured products when Federal funds (Grant Agreement or Cooperative Agreement) are used.

Instructions:

Bidder to complete the Buy America Certification listed below. Bidder shall certify EITHER COMPLIANCE OR NON-COMPLIANCE (not both). This Certification MUST BE submitted with the Bidder's bid response. Special Note: Make sure you have signed only one of the above statements – either Compliance OR Non-Compliance (not both).

Certificate of Compliance

The bidder or offeror hereby certifies that it **will meet** the requirements of 49 U.S.C. 5323(j)(1), as amended, and the applicable regulations in 49 CFR Part 661.

Signature Rob Strauss

Company Name SAFE STEP LLC

Title REGIONAL MANAGER

Date 4-10-13

Certificate of Non-Compliance

The bidder or offeror hereby certifies that it **cannot comply** with the requirements of 49 U.S.C. 5323(j)(1), as amended, and 49 C.F.R. 661, but it may qualify for an exception pursuant to 49 U.S.C. 5323(j)(2)(A), 5323(j)(2)(B), or 5323(j)(2)(D), and 49 C.F.R. 661.7.

Signature _____

Company Name _____

Title _____

Date _____

AFTER THIS CERTIFICATE HAS BEEN EXECUTED, A BIDDER MAY NOT SEEK A WAIVER.

Note: The U.S./Canadian Free Trade Agreement does not supersede the Buy America requirement.

Suspension or Debarment Certificate

Non-Federal entities are prohibited from contracting with or making sub-awards under covered transactions to parties that are suspended or debarred or whose principals are suspended or debarred. Covered transactions include procurement for goods or services equal to or in excess of \$100,000.00. Contractors receiving individual awards for \$100,000.00 or more and all sub-recipients must certify that the organization and its principals are not suspended or debarred.

By submitting this offer and signing this certificate, the Bidder certifies to the best of its knowledge and belief, that the company and its principals:

1. Are not presently debarred, suspended, proposed for debarment, declared ineligible or voluntarily excluded from covered transactions by any federal, state or local governmental entity, department or agency;
2. Have not within a three-year period preceding this Bid been convicted of or had a civil judgment rendered against them for commission of fraud or a criminal offense in connection with obtaining, attempting to obtain, or performing a public (Federal, State or local) transaction or contract under a public transaction, or convicted of or had a civil judgment against them for a violation of Federal or state antitrust statutes or commission of embezzlement, theft, forgery, bribery, falsification or destruction of records, making false statements, or receiving stolen property;
3. Are not presently indicted for or otherwise criminally or civilly charged by a governmental entity (Federal, State, or local) with commission of any of the offenses enumerated in paragraph (2) of this certification; and
4. Have not within a three-year period preceding this application/proposal/contract had one or more public transactions (Federal, State or local) terminated for cause or default.

If the Bidder is unable to certify to any of the statements in this certification, Bidder shall attach an explanation to this certification.

Company Name: SAFE STEP LLC

Address: P.O. BOX 411 105 GREENDALE RD

City: HORTONVILLE, WI Zip Code: 54944

Telephone: (920) 540-7414 Fax Number: (866) 479-1069

E-mail Address: ROB@NOTRIPPIN.COM

Authorized Company Signature: 

Print Signature Name: ROB STRAUSS Title of Official: REGIONAL MANAGER

Date: 4-10-13

Village of Downers Grove

CAMPAIGN DISCLOSURE CERTIFICATE

Any contractor, proposer, bidder or vendor who responds by submitting a bid or proposal to the Village of Downers Grove shall be required to submit with its bid submission, an executed Campaign Disclosure Certificate.

The Campaign Disclosure Certificate is required pursuant to the Village of Downers Grove Council Policy on Ethical Standards and is applicable to those campaign contributions made to any member of the Village Council.

Said Campaign Disclosure Certificate requires any individual or entity bidding to disclose campaign contributions, as defined in Section 9-1.4 of the Election Code (10 ILCS 5/9-1.4), made to current members of the Village Council within the five (5) year period preceding the date of the bid or proposal release.

By signing the bid documents, contractor/proposer/bidder/vendor agrees to refrain from making any campaign contributions as defined in Section 9-1.4 of the Election Code (10 ILCS 5/9-1.4) to any Village Council member and any challengers seeking to serve as a member of the Downers Grove Village Council.

Under penalty of perjury, I declare:

Bidder/vendor has not contributed to any elected Village position within the last five (5) years.

Rob Strauss
Signature

ROB STRAUSS
Print Name

Bidder/vendor has contributed a campaign contribution to a current member of the Village Council within the last five (5) years.

Print the following information:

Name of Contributor: _____
(company or individual)

To whom contribution was made: _____

Year contribution made: _____ Amount: \$ _____

Signature

Print Name

Village of Downers Grove

BID SUBMITTAL CHECKLIST

Each Bidder's Bid Package must be submitted with all requisite forms properly completed, and all documentation included. The following list is not all-inclusive, but is designed to facilitate a good, competitive bidding environment.

1. Instructions to Bidders read and understood. Any questions must be asked according to the instructions.
2. Cover sheet filled-in
3. Bid Form copies filled-in. All copies must have original signatures and seals on them.
4. Bid Bond or cashier's check enclosed with bid package.
5. Schedule of Prices completed. Check your math!
6. Bidder Certifications signed and sealed.
7. Letter from Surety ensuring issuance of Performance and Labor Bonds.
8. Letter from Insurance Agent or Carrier ensuring issuance of required job coverage.
9. Municipal Reference List completed.
10. Vendor request form W-9 completed.
11. Affidavit (IDOT Form BC-57, or similar).
12. Bid package properly sealed and labeled before delivery. If sending by mail or messenger, enclose in a second outer envelope or container. Project plan sheets do not have to be included with the bid package.

Village of Downers Grove

CAMPAIGN DISCLOSURE CERTIFICATE

Any contractor, proposer, bidder or vendor who responds by submitting a bid or proposal to the Village of Downers Grove shall be required to submit with its bid submission, an executed Campaign Disclosure Certificate.

The Campaign Disclosure Certificate is required pursuant to the Village of Downers Grove Council Policy on Ethical Standards and is applicable to those campaign contributions made to any member of the Village Council.

Said Campaign Disclosure Certificate requires any individual or entity bidding to disclose campaign contributions, as defined in Section 9-1.4 of the Election Code (10 ILCS 5/9-1.4), made to current members of the Village Council within the five (5) year period preceding the date of the bid or proposal release.

By signing the bid documents, contractor/proposer/bidder/vendor agrees to refrain from making any campaign contributions as defined in Section 9-1.4 of the Election Code (10 ILCS 5/9-1.4) to any Village Council member and any challengers seeking to serve as a member of the Downers Grove Village Council.

Under penalty of perjury, I declare:

Bidder/vendor has not contributed to any elected Village position within the last five (5) years.

Rob Strauss
Signature

ROB STRAUSS
Print Name

Bidder/vendor has contributed a campaign contribution to a current member of the Village Council within the last five (5) years.

Print the following information:

Name of Contributor: _____
(company or individual)

To whom contribution was made: _____

Year contribution made: _____ Amount: \$ _____

Signature

Print Name

V. BID and CONTRACT FORM (Village)

*****THIS BID WHEN ACCEPTED AND SIGNED BY AN AUTHORIZED SIGNATORY OF THE VILLAGE OF DOWNERS GROVE SHALL BECOME A CONTRACT BINDING UPON BOTH PARTIES.**

Entire Form Must Be Completed If a Submitted Bid Is To Be Considered For Award

BIDDER:

SAFE STEP LLC
Company Name

4/10/13
Date

POBox 411 105 GREENDALE
Street Address of Company

ROB@NOTRIPPIN.COM
E-mail Address

HORTONVILLE, WI 54944
City, State, Zip

ROB STRAUSS
Contact Name (Print)

920-540-7414
Business Phone

920-540-7414
24-Hour Telephone

866-479-1069
Business Fax

Rob Strauss
Signature of Officer, Partner or Sole Proprietor

ATTEST: if a Corporation

ROB STRAUSS REGIONAL MANAGER
Print Name & Title

Signature of Corporation Secretary

We hereby agree to furnish the Village of Downers Grove all necessary materials, equipment, labor, etc. to complete the project within **30** calendar days from the date of the Notice to Proceed in accordance with the provisions, instructions and specifications for the unit prices shown on the Schedule of Prices.

VILLAGE OF DOWNERS GROVE:

ATTEST:

Authorized Signature

Village Clerk

Title

Date

Date

In compliance with the specifications, the above-signed offers and agrees, if this Bid is accepted within **90** calendar days from the date of opening, to furnish any or all of the services upon which prices are quoted, at the price set opposite each item, delivered at the designated point within the time specified above.

V. BID and CONTRACT FORM (Contractor)

*****THIS BID WHEN ACCEPTED AND SIGNED BY AN AUTHORIZED SIGNATORY OF THE VILLAGE OF DOWNERS GROVE SHALL BECOME A CONTRACT BINDING UPON BOTH PARTIES.**

Entire Form Must Be Completed If a Submitted Bid Is To Be Considered For Award

BIDDER:

SAFE STEP LLC
Company Name

4-10-13
Date

PO BOX 411 105 GREENDALE
Street Address of Company

ROB@NOTRIPPIN.COM
E-mail Address

HORTONVILLE, WI 54944
City, State, Zip

ROB STRAUSS
Contact Name (Print)

920-540-7414
Business Phone

920-540-7414
24-Hour Telephone

866-479-1069
Business Fax

[Signature]
Signature of Officer, Partner or Sole Proprietor

ATTEST: if a Corporation

Signature of Corporation Secretary

ROB STRAUSS
Print Name & Title

We hereby agree to furnish the Village of Downers Grove all necessary materials, equipment, labor, etc. to complete the project within 30 calendar days from the date of the Notice to Proceed in accordance with the provisions, instructions and specifications for the unit prices shown on the Schedule of Prices.

VILLAGE OF DOWNERS GROVE:

Authorized Signature

Title

Date

ATTEST:

Village Clerk

Date

In compliance with the specifications, the above-signed offers and agrees, if this Bid is accepted within 90 calendar days from the date of opening, to furnish any or all of the services upon which prices are quoted, at the price set opposite each item, delivered at the designated point within the time specified above.



Village of Downers Grove Contractor Evaluation

Contractor: Safe Step LLC

Project: 2012 Sidewalk Rehabilitation Program (S-006)

Primary Contact: Rob Strauss, Regional Manager

Phone: (920) 540-7414

Time Period: June 2012

On Schedule (allowing for uncontrollable circumstances) yes no

Provide details if early or late completion: The Contractor mobilized additional crews to accommodate the number of locations requiring saw cutting resulting in completing the project early.

Change Orders (attach information if needed): One negative change order in amount of \$4,632.66.

Difficulties / Positives: Employees are very pleasant to work with. They communicate very well, and are very responsive to directives given to them.

Interaction with public:

excellent good average poor

(Attach information on any complaints or compliments)

General Level of Satisfaction with work:

Well Satisfied Satisfied Not Satisfied

Recommendations for future work with this vendor: I would recommend this vendor for future work.

Reviewers: Brian Park, STAFF ENGR.

Date: JULY 2012



Village of Downers Grove Change Order

Project Name: 2012 Sidewalk Rehabilitation Program **Date:** 07/06/12
Project No: S-006-12 **No:** 1
Contractor: Safe Step, LLC **SHEET:** 1 OF 2

You are directed to make the following changes to this contract:

This proposed balanced change order reflects a negative balance of final agreed-to contract quantities.

The original contract sum was:.....	(1)	\$	48,300.00
Net amount of previous change orders:.....	(2)	\$	-
Current contract amount (1) + (2):.....	(3)	\$	48,300.00
This Proposed Change Order:.....	(4)		(\$4,632.66)
Proposed Revised Contract Amount (3) + (4):.....	(5)	\$	43,667.34

Net of Change Orders Pending Approval (2) + (4): \$ (4,632.66)
 Budget Estimate:..... \$ 50,000.00
 Original Completion Date:..... 7/17/2012
 Time Extension or Reduction:..... 0
 Total Contract Time (Pending Approval):..... N/A

RECOMMENDED FOR ACCEPTANCE:

APPROVED:

Project Engineer

Date

Village Manager

Date

Director of Public Works

Contractor

Date

It is understood that as part of this change order that the Contractor agrees that all bonds, permits, insurance, and guarantees are hereby extended to incorporate this Change Order.

2013-2017 Capital Project Sheet

Project # **S-006**

Project Description **Replacement Sidewalk Program**

Project summary, justification and alignment to Strategic Plan

This project provides for the replacement of sidewalks with a grade difference of 1-1/8" or more (tripping hazards) as well as repair of sidewalk which has cracked into more than three pieces. The Village maintains over 5 million square feet (SF) of sidewalk which has a life expectancy of 50 to 100 years. Beginning in FY2009, a 5% escalator was included to reflect increasing costs for sidewalk construction.

Cost Summary	New	Maintenance	Replacement	FY 2013	FY 2014	FY 2015	FY 2016	FY 2017	Future	TOTAL
									Years	
Professional Services										-
Land Acquisition										-
Infrastructure		X		191,500	201,075	211,000	221,000	232,000		1,056,575
Building										-
Machinery/Equipment										-
Other/Miscellaneous										-
TOTAL COST				191,500	201,075	211,000	221,000	232,000	-	1,056,575

Funding Source(s)

220-Capital Improvements Fund	▼	191,500	201,075	211,000	221,000	232,000		1,056,575
	▼							-
	▼							-
	▼							-
TOTAL FUNDING SOURCES		191,500	201,075	211,000	221,000	232,000	-	1,056,575

Project status and completed work Annual Program.

Grants (funded or applied for) related to the project: None.

Impact-annual operating expenses	FY 2013	FY 2014	FY 2015	FY 2016	FY 2017	Future Yrs	TOTAL
Projected Operating Expense Impact:							-

Repaired sidewalk will reduce liability costs.

Map/Pictures of Project

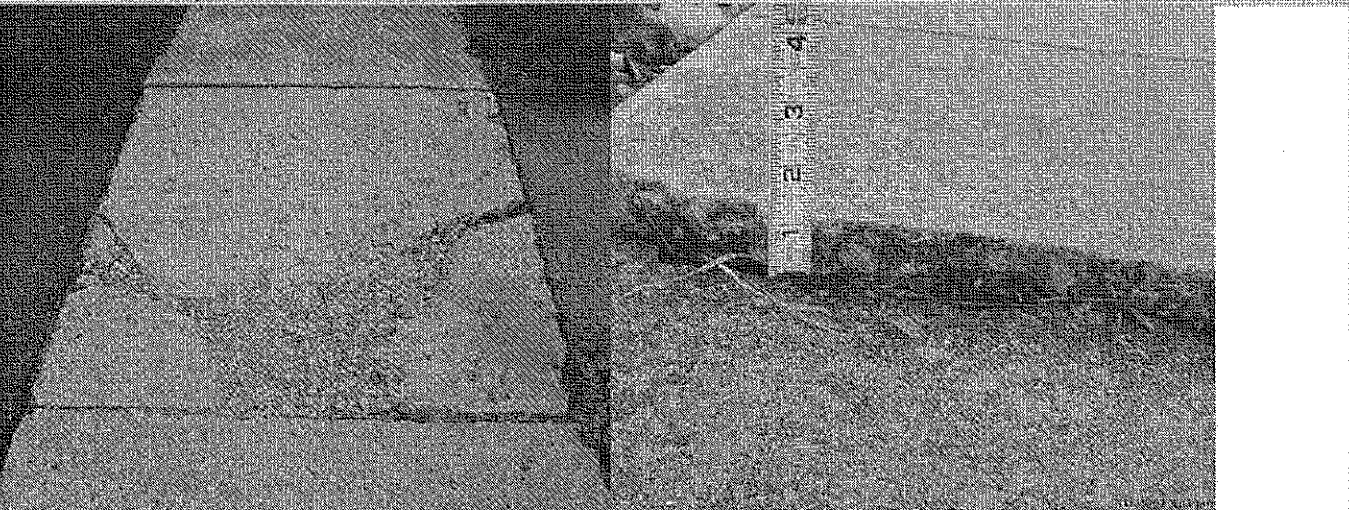

Priority Score: **A**

Project Manager:

Andy Sikich

Program: **341**

Department:

Public Works

2013-2017 Capital Project Sheet

Project # **S-009**

Project Description **Brick Sidewalk Remnant Removal & Replacement**

Project summary, justification and alignment to Strategic Plan

There are several small segments of old brick sidewalks in the residential areas near downtown, in particular around Maple Avenue east of Main Street. These brick sidewalks do not meet the requirements of the American's with Disabilities Act (ADA), and need to be replaced with 5' wide concrete walks.

Cost Summary	New	Maintenance	Replacement	FY 2013	FY 2014	FY 2015	FY 2016	FY 2017	Future Years	TOTAL
				Professional Services				2,000		
Land Acquisition										-
Infrastructure		X		48,000						48,000
Building										-
Machinery/Equipment										-
Other/Miscellaneous										-
TOTAL COST				50,000	-	-	-	-	-	50,000
Funding Source(s)										
220-Capital Improvements Fund	▼			50,000						50,000
	▼									-
	▼									-
	▼									-
TOTAL FUNDING SOURCES				50,000	-	-	-	-	-	50,000

Project status and completed work

It is anticipated that this project will be designed and constructed in 2013.

Grants (funded or applied for) related to the project

Impact-annual operating expenses	FY 2013	FY 2014	FY 2015	FY 2016	FY 2017	Future Yrs	TOTAL
Projected Operating Expense Impact:							-

Repaired sidewalk will reduce liability costs.

Map/Pictures of Project

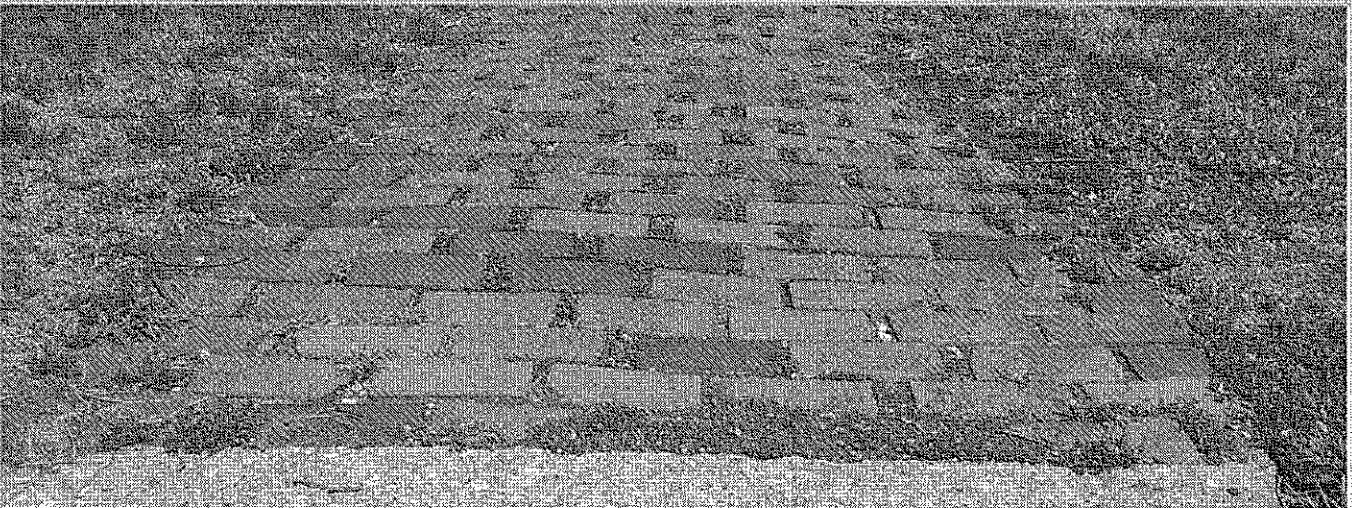

Priority Score

Project Manager

Andy Sikich

Program 341

Department

Public Works